

Nous vous remercions de votre choix et de votre confiance. Le radiateur que vous venez d'acquérir a été soumis à de nombreux tests et contrôles afin d'en assurer la qualité et ainsi vous apporter une entière satisfaction.

Il vous permet de chauffer votre pièce et de réaliser des économies d'énergie.

FR

**Prenez le temps de lire la notice pour mieux comprendre l'utilisation de votre radiateur et découvrir les conseils d'utilisation pour améliorer votre bien-être.  
Conservez la notice, même après l'installation du radiateur.**

## Sommaire

(RMGD-MK21 / RMGVD-MK21)

<b>Mise en garde</b> .....	2
<b>Identifier les références du radiateur</b> .....	2
<b>Installation</b> .....	3
Installation du radiateur .....	3
Fixer le support mural au mur .....	4
Raccorder le radiateur .....	5
Installer l'appareil sur son support mural .....	7
<b>Fonctionnement</b> .....	7
Le boîtier de commande (suivant modèle) .....	7
Les différents affichages .....	7
Les différents modes de chauffage .....	8
<b>Première utilisation</b> .....	8
Mettre en marche l'appareil .....	8
Mettre en arrêt chauffage l'appareil .....	9
Régler l'heure et le jour .....	9
<b>Utilisation des modes</b> .....	10
Chauffer votre pièce : utilisation du mode confort .....	10
s'absenter quelques heures : utilisation du mode eco .....	11
S'absenter plus de 48 heures : .....	12
utilisation du mode hors gel .....	12
Programmer votre période de chauffe : utilisation du mode programmation interne .....	12
Programmer votre période de chauffe : utilisation du mode programmation centralisée .....	14
<b>Utiliser les fonctions d'économie d'énergie :</b> .....	14
Fonction détection automatique d'ouverture/fermeture de fenêtres .....	14
Fonction indicateur de consommation .....	15
Verrouiller les commandes .....	15
<b>Réglages avancés</b> .....	16
Température maxi : t° max .....	16
Étalonner la température .....	16
Brider les réglages .....	17
Enregistrer un code d'accès .....	17
Retour au réglage de base usine .....	18
Le délestage .....	18
Entretien .....	18
En cas de problème .....	19

## Mise en garde



- Attention surface très chaude, caution hot surface.

### **ATTENTION :**

**Certaines parties de ce produit peuvent devenir très chaudes et provoquer des brûlures. Il faut prêter une attention particulière en présence d'enfants et de personnes vulnérables.**

Il convient de maintenir à distance de cet appareil les enfants de moins de 3 ans, à moins qu'ils ne soient sous une surveillance continue.

Les enfants âgés entre 3 ans et 8 ans doivent uniquement mettre l'appareil en marche ou à l'arrêt, à condition que ce dernier ait été placé ou installé dans une position normale prévue et que ces enfants disposent d'une surveillance ou aient reçu des instructions quant à l'utilisation de l'appareil en toute sécurité et en comprenant bien les dangers potentiels. Les enfants âgés entre 3 ans et 8 ans ne doivent ni brancher, ni régler ni nettoyer l'appareil, et ni réaliser l'entretien de l'utilisateur.

Cet appareil peut être utilisé par des enfants âgés d'au moins 8 ans et par des personnes ayant des capacités physiques, sensorielles ou mentales réduites ou dénuées d'expérience ou de connaissance, s'ils (si elles) sont correctement surveillé(e)s ou si des instructions relatives à l'utilisation de l'appareil en toute sécurité leur ont été données et si les risques encourus ont été appréhendés. Les enfants ne doivent pas jouer avec l'appareil. Le nettoyage et l'entretien par l'utilisateur ne doivent pas être effectués par des enfants sans surveillance.



- Afin d'éviter une surchauffe et pour des raisons de sécurité, ne pas couvrir l'appareil de chauffage.

La notice d'utilisation de cet appareil est disponible sur le site internet ou en contactant le service après-vente.

## Identifier les références du radiateur

Elles sont situées sur le côté droit de l'appareil.

Le Code commercial et le Numéro de série identifient auprès du constructeur le radiateur que vous venez d'acquérir.

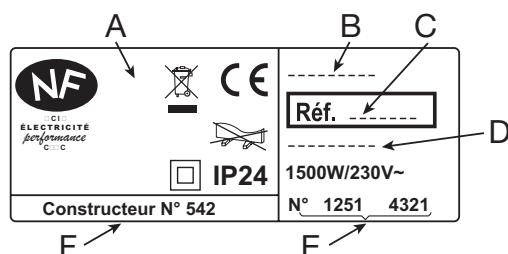

A Normes, labels de qualité

B Nom commercial

**C Référence commercial**

D Référence de fabrication

**E N° de série**

F N° de constructeur



Les appareils munis de ce symbole ne doivent pas être mis avec les ordures ménagères, mais doivent être collectés séparément et recyclés.

La collecte et le recyclage des produits en fin de vie doivent être effectués selon les dispositions et les décrets locaux.

### Caractéristiques du radiateur :

CAT C : Appareil satisfaisant à la norme NF Electricité Performance selon les critères de la catégorie indiquée.

IP24 : Appareil protégé contre les pénétrations de corps solides étrangers et les projections d'eau.

Classe II : Double isolation (*pas de raccordement à la terre*).

## Installation

### INSTALLATION DU RADIATEUR

- Cet appareil a été conçu pour être installé dans un local résidentiel. Dans tout autre cas, veuillez consulter votre distributeur.

- L'installation doit être faite dans les règles de l'art et conforme aux normes en vigueur dans le pays d'installation (NFC 15-100 pour la France).

- Si vous avez un revêtement mural posé sur mousse, il faut mettre une cale sous le support de l'appareil d'épaisseur égale à celle de la mousse afin de conserver un espace libre derrière pour ne pas perturber sa régulation.

#### Ne pas installer l'appareil :

- Dans un courant d'air susceptible de perturber sa régulation (sous une Ventilation Mécanique Centralisée, etc).

- Sous une prise de courant fixe.

- Dans le volume 1 des salles de bains.

Les appareils utilisés dans les salles de bains doivent être installés de façon telle que les interrupteurs et autres dispositifs de commande de l'appareil ne puissent être touchés par une personne dans la baignoire ou la douche.

Modèle Horizontal

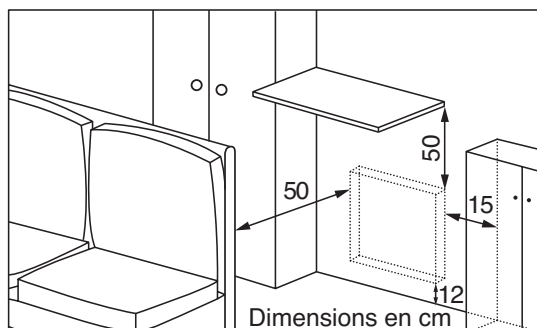

Modèle Vertical

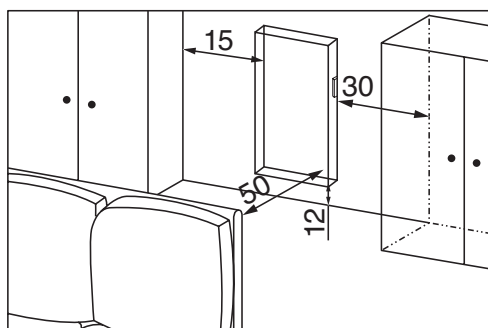

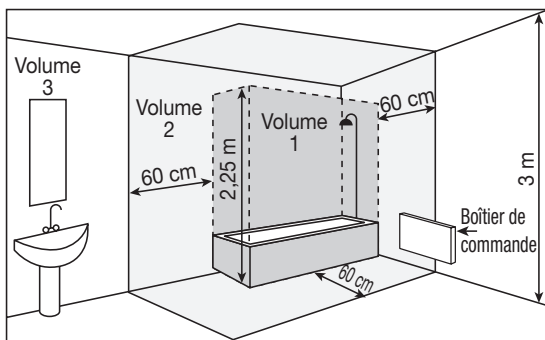

<b>Volume 1</b>	Pas d'appareil électrique
<b>Volume 2</b>	Appareil électrique Classe II - IP X4
<b>Volume 3</b>	Appareil électrique Classe II

## FIXER LE SUPPORT MURAL AU MUR

### Modèle Horizontal

<b>1</b>		<b>2</b>	
	<p>Posez le support mural au sol et contre le mur. Repérez les points de perçage A. Ceux-ci donnent la position des fixations inférieures.</p>		<p>Remontez le support mural en faisant coïncider les points précédemment repérés avec les trous de perçage A. Pointez les 2 points de perçage B à l'aide d'un stylo. Vous avez ainsi repéré les 4 points de perçage.</p>
<b>3</b>	<p>Percez les 4 trous et mettez les chevilles adaptées à votre mur (ex. plaque de plâtre, béton). Positionnez le support et vissez.</p>		

## Modèle Vertical

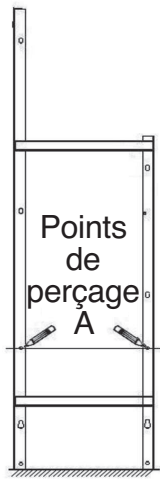
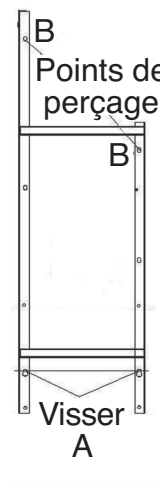
<b>1</b>		<b>2</b>	
	<p>Posez le support mural au sol. Repérez les points de perçage A. Ceux-ci donnent la position des fixations inférieures.</p>		<p>Remontez le support mural en faisant coïncider les points de perçage A avec les trous inférieurs du support mural. Pointez les 2 points de perçage B à l'aide d'un stylo.</p>
<b>3</b>	<p>Percez les 4 trous et mettez les chevilles adaptées à votre mur (ex. plaque de plâtre, béton). Positionnez le support mural et vissez.</p>		

## RACCORDER LE RADIATEUR

- L'appareil doit être alimenté en 230 V Monophasé 50Hz.
- L'alimentation de l'appareil doit être directement raccordée au réseau après le dispositif de coupure omnipolaire ayant une distance d'ouverture des contacts d'au moins 3mm sans interrupteur intermédiaire (horloge, relais mécanique et statique, thermostat d'ambiance, etc...).
- Le raccordement au secteur se fera à l'aide du câble 3 fils (Marron = Phase, Bleu = Neutre, Noir = Fil pilote) par l'intermédiaire d'un boîtier de raccordement. Dans des locaux humides comme les cuisines et les salles de bains, il faut installer le boîtier de raccordement au moins à 25 cm du sol.
- L'installation doit être équipée d'un dispositif de protection de type disjoncteur.

**Le raccordement à la terre est interdit.**

**Ne pas brancher le fil pilote (fil noir) de l'appareil à la terre.**

- Si le câble d'alimentation est endommagé, il doit être remplacé par le fabricant, son service après-vente ou une personne de qualification similaire afin d'éviter un danger.

- Si l'appareil pilote ou piloté est protégé par un différentiel 30mA (ex : salle de bains), il est nécessaire de protéger l'alimentation du fil pilote sur ce différentiel.

- Si vous voulez utiliser un délesteur, celui-ci ne doit pas couper l'alimentation électrique des radiateurs car il y a incompatibilité avec nos radiateurs. Cela détériorerait le thermostat.

### Schéma de raccordement du radiateur

Coupez le courant et branchez les fils d'après le schéma suivant :

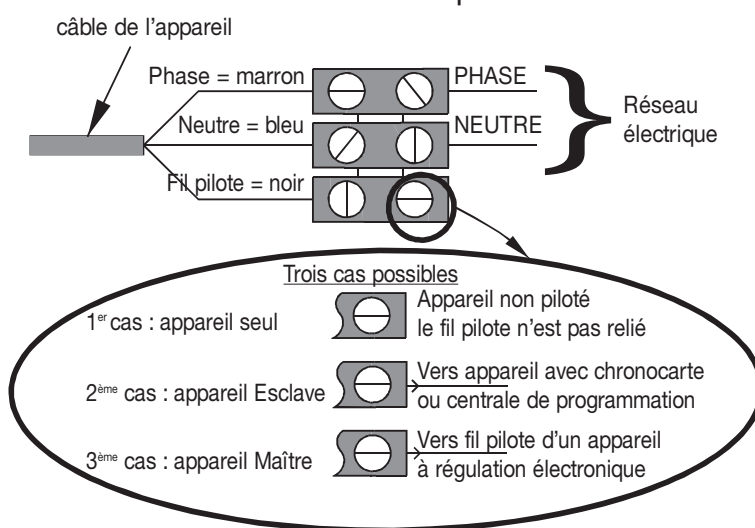

### Test de raccordement du fil pilote

Vous pouvez raccorder le fil pilote si votre maison est équipée d'une centrale de programmation, d'un programmeur ou d'un gestionnaire.

Dans ce cas, pour vérifier la transmission correcte des ordres de programmation, procédez aux vérifications suivantes :

Ordres reçus	Oscilloscope Réf/Neutre	Mode obtenu
0 volt	—	CONFORT
230 V - 3 s/5 min	⚡	CONFORT - 1° C
230V - 7 s/5 min	⚡	CONFORT - 2° C
230 V	⤴	ECO
- 115 V négatif	⤵	HORS GEL
+ 115 V positif	⤶	ARRÊT CHAUFFAGE

## INSTALLER L'APPAREIL SUR SON SUPPORT MURAL

- Posez l'appareil sur le support S selon le schéma
- Ramenez l'appareil vers le support puis le relevez (flèche 1 et 2)
- Introduire les pattes du support dans les trous de l'appareil, rabaisser (flèche 3), votre appareil est fixé.

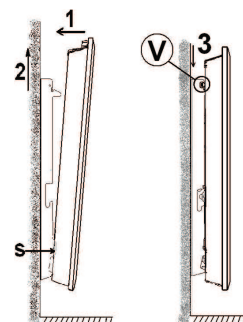

## Fonctionnement

### Le boîtier de commande (suivant modèle)

Pour plus de confort et d'économie, votre appareil est doté d'un boîtier de commande à affichage digital. Il vous permet de régler toutes les fonctionnalités du radiateur.

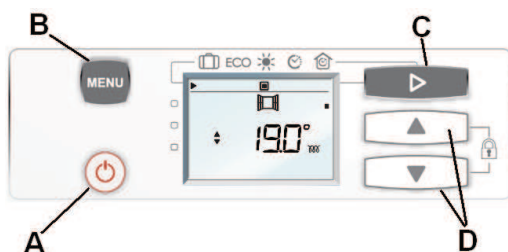

- A Mise en marche/mise en veille
- B Réglages
- C Sélection des modes de chauffage
- D Réglage de la température





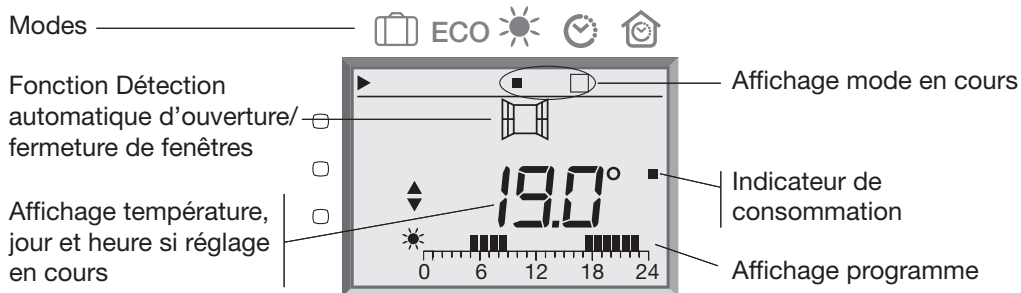

- A Mise en arrêt
- B Mise en marche/ Réglages
- C Sélection des modes de chauffage
- D Réglage de la température

### Les différents affichages





Au bout de 2 minutes d'inactivité, l'écran revient à l'affichage en cours

## LES DIFFÉRENTS MODES DE CHAUFFAGE



Pictogramme	Désignation	Quand utiliser ce mode ?
	Confort	Vous êtes à la maison.
<b>ECO</b>	Eco	Vous êtes absents pour 2 à 48h ou vous dormez.
	Hors Gel	Vous êtes absents plus de 48h ou c'est l'été. La température Hors Gel est fixée à 7°C environ et ne peut être modifiée.
	Programmation interne	Vous souhaitez que votre radiateur suive les ordres d'une programmation. Vous pouvez choisir un des cinq programmes proposés par un double appui sur la touche MENU (B). Reportez-vous page 11 pour des explications détaillées.
	Programmation centralisée	Ces modes de chauffage sont accessibles uniquement en cas de présence d'un système de programmation centralisé (par le Fil Pilote) sur votre installation.

### Première utilisation

#### METTRE EN MARCHÉ L'APPAREIL

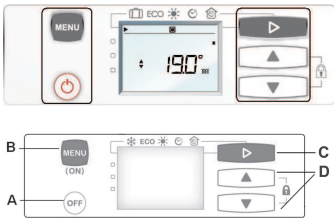

<p>Pour mettre en marche l'appareil, appuyez sur la touche Mise en marche (A ou B selon modèle)</p>	 	 <p>L'appareil affiche la température de confort. Lors de la première mise en marche, l'appareil est réglé en mode Confort à 19°C.</p>
---	---	---

#### ACTIVER L'ÉCRAN











<p>Si l'écran n'est pas éclairé, appuyez sur n'importe quelle touche pour réactiver l'éclairage de l'écran.</p>		 <p>Vous pouvez maintenant appuyer sur la touche correspondant au réglage que vous souhaitez faire.</p>
---	---	---



## METTRE EN ARRÊT CHAUFFAGE L'APPAREIL

<p>Pour mettre en arrêt l'appareil, maintenez appuyée la touche Arrêt chauffage (A ou B selon modèle).</p>		 <p>L'écran s'éteint.</p>
--	---	--

## RÉGLER L'HEURE ET LE JOUR



<p>Pour accéder au réglage du jour et de l'heure, appuyez plusieurs fois sur la touche Menu (B) jusqu'à sélection de la clé </p>		 <p>Les lettres sur l'écran s'affichent : vous pouvez commencer le réglage de l'heure.</p>
<p>Pour modifier l'heure, appuyez sur ▲ ou ▼ (D), les heures clignotent. Appuyez à nouveau sur ▲ ou ▼ (D) pour faire varier l'heure.</p>		 <p>Après 5s d'inactivité l'heure est validée automatiquement.</p>
<p>Après le réglage des heures, vous pouvez accéder au réglage des minutes en appuyant sur ► (C). Réglez les minutes en appuyant sur les touches ▲ ou ▼ (D)</p>		 <p>Après 5s d'inactivité les minutes sont validées automatiquement.</p>
<p>Après le réglage des heures / minutes, vous pouvez accéder au réglage du jour en appuyant sur ► (C).</p>		 <p>Les lettres sur l'écran s'affichent, vous pouvez commencer le réglage du jour.</p>
<p>Pour modifier le jour, appuyez sur ▲ ou ▼ (D), le jour clignote. Appuyez à nouveau sur ▲ ou ▼ (D) pour faire varier le jour.</p>		 <p>Après 5s d'inactivité le jour est validé automatiquement.</p>

## Utilisation des modes

### CHAUFFER VOTRE PIÈCE : UTILISATION DU MODE CONFORT



Ce mode vous permet d'avoir la température ambiante souhaitée dans la pièce. Les voyants de l'indicateur de consommation vont vous permettre d'optimiser votre réglage (voir en page 15).

#### Comment activer ce mode ?

<p>Pour activer le mode Confort, appuyez plusieurs fois sur la touche de sélection des modes jusqu'à ce que le curseur soit sur le mode Confort ☀</p>		 <p>Par défaut, la température Confort est à 19°C.</p>
---	---	---



La température Confort conseillée est de 19° C.  
Le mode Confort va de 12,5° C à 28° C.

#### Comment modifier la température souhaitée ?

<p>Pour modifier la température affichée, appuyez sur les touches ▲ ou ▼, la température clignote. Appuyez à nouveau sur ▲ ou ▼ pour faire varier la température.</p>		 <p>Le témoin de chauffe ☀ apparaît à l'écran si la température ambiante est inférieure à celle affichée. Après 5s d'inactivité la température est validée.</p>
---	---	--





Il faut 6 heures minimum pour que la température se stabilise dans la pièce.







<p>Si la température de la pièce ne vous convient pas, appuyez sur les touches ▲ ou ▼, la température clignote. Appuyez à nouveau sur ▲ ou ▼ pour ajuster la température.</p>		 <p>Plus la température indiquée sur l'écran est élevée, plus le voyant de l'indicateur de consommation se décalera vers le bas (indicateur orange et rouge)</p>
---	---	---

### S'ABSENTER QUELQUES HEURES : UTILISATION DU MODE ECO

Il est conseillé d'utiliser ce mode pour des périodes d'absences comprises entre 2 heures et 48 heures, ou pendant la nuit, notamment dans les chambres.

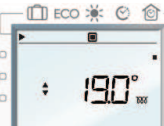
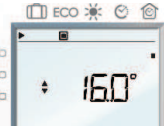
La température ECO maximum est de 19°C, ou 0,5°C inférieur à la température confort.

<p>Pour activer le mode ECO, appuyez plusieurs fois sur ► (C) jusqu'à ce que le curseur soit sur le mode ECO.</p>		 <p>Par défaut, la température ECO est à 15,5°C.</p>
---	---	--

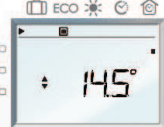
	Affichage Confort	Affichage Eco
<p>Passage du mode Confort au mode ECO : température abaissée de -3,5°C par rapport à la température Confort.</p>		
<p>Le pictogramme -3,5°C n'apparaît pas à l'écran : l'écart avec la température Confort réglée est différent de -3,5°C.</p>		
<p>Si vous abaissez la température Confort en dessous de la température Eco, la température Eco baissera automatiquement de -0,5°C par rapport à la température Confort.</p>		
<p>Si vous augmentez la température Confort, la température Eco ne change pas.</p>		

### Comment modifier la température souhaitée ?

Si vous le souhaitez, vous pouvez modifier la température affichée en appuyant sur ▲ ou ▼ (D), la température clignote. Appuyez à nouveau sur ▲ ou ▼ (D) pour faire varier la température.



Après 5s d'inactivité la température ECO est validée automatiquement.

### S'ABSENTER PLUS DE 48 HEURES : UTILISATION DU MODE HORS GEL ☑

Pour activer le mode Hors Gel ☑, appuyez plusieurs fois sur ► (C) jusqu'à ce que le curseur soit sur le mode Hors Gel ☑.

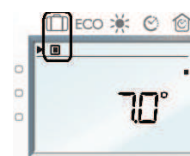

La température Hors Gel ☑ est préréglée à 7° C (±3° C) et ne peut pas être modifiée.

### PROGRAMMER VOTRE PÉRIODE DE CHAUFFE : UTILISATION DU MODE PROGRAMMATION INTERNE ⌚

Avant de régler la programmation, assurez-vous que l'heure, le jour soient réglés dans l'appareil. Sinon, reportez-vous au paragraphe régler l'heure et le jour page 8.

#### Description

Vous pouvez choisir vos périodes de température Confort ☀ et ECO en utilisant un des cinq programmes préenregistrés.

5 programmes sont préenregistrés : P1, P2, P3, P4 et P5 et non modifiables.

	0h	1h	2h	3h	4h	5h	6h	7h	8h	9h	10h	11h	12h	13h	14h	15h	16h	17h	18h	19h	20h	21h	22h	23h
P1						■	■	■	■	■	■	■	■	■	■	■	■	■	■	■	■	■	■	■
P2										■	■	■	■	■	■	■	■	■	■	■	■	■	■	■
P3													■	■	■	■	■	■	■	■	■	■	■	■
P4	■	■	■	■	■	■	■	■	■	■	■	■	■	■	■	■	■	■	■	■	■	■	■	■
P5	■	■	■	■	■	■	■	■	■	■	■	■	■	■	■	■	■	■	■	■	■	■	■	■

**P1** est préconisé pour une présence constante, par exemple le week-end (mode Eco de 23 h à 5 h, mode confort de 5 h à 23 h).



**P2** est préconisé si vous êtes absents la journée (mode Eco de 23 h à 5 h et de 9 h à 17 h, mode Confort de 5 h à 9 h et de 17 h à 23 h).

**P3** est préconisé si vous êtes absents la journée, mais que vous rentrez le midi (mode Eco de 23 h à 5 h, de 9 h à 12 h et de 14 h à 17 h, mode Confort de 5 h à 9 h, de 12 h à 14 h et de 17 h à 23 h).

**P4** Confort permanent.

**P5** Eco permanent.

### Comment attribuer un programme journalier ?

Pour accéder au programme journalier, appuyez plusieurs fois sur  jusqu'au picto .

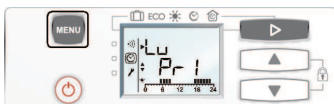

Pour le lundi, le programme par défaut est P1.



### Conserver le programme sélectionné ?

Si vous souhaitez conserver le programme P1 du lundi : appuyez sur  (C) pour passer au jour suivant.



MA (mardi) s'affiche à l'écran avec le programme P1 par défaut.

### Modifier le programme sélectionné ?

Vous souhaitez modifier le programme du lundi : appuyez sur  ou  (D) pour faire défiler les programmes jusqu'au programme désiré.





Lu (lundi) s'affiche à l'écran avec le programme choisi.  
Le programme clignote et après 5s d'inactivité, le programme choisi est validé automatiquement.

### Attribuer un programme journalier à tous les jours de la semaine

Vous procédez de la même façon pour tous les jours de la semaine, jusqu'au dimanche, soit en conservant le programme sélectionné, soit en le modifiant.

### Comment activer la programmation interne ?

Pour activer le mode Programmation interne, appuyez plusieurs fois sur  (C), jusqu'à ce que le curseur soit sur le mode Programmation interne .

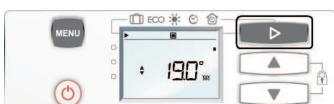

Le picto programmation interne et l'allure en cours selon le programme choisi s'affiche à l'écran.



## PROGRAMMER VOTRE PÉRIODE DE CHAUFFE : UTILISATION DU MODE PROGRAMMATION CENTRALISÉE

Avant de régler la programmation, assurez-vous que l'heure, le jour soient réglés dans l'appareil. Sinon, reportez-vous au paragraphe «régler l'heure et le jour» page 8.

 correspond à l'utilisation d'un programmateur centralisé.



**NB :** En cas d'absence d'ordre sur le fil pilote, le radiateur fonctionne en mode Confort. Lors du passage du mode Confort vers le mode Eco, le temps de basculement est de l'ordre de 12 secondes. Les ordres Hors Gel et Déstase sont prioritaires par rapport aux modes Eco et Confort.

### Comment activer la programmation centralisée ?

<p>Pour activer le mode Programmation centralisée, appuyez plusieurs fois sur ► (C), jusqu'à ce que le curseur soit sur le mode Programmation centralisée .</p>		 <p>Le picto programmation centralisée et l'allure en cours s'affichent à l'écran.</p>
--	---	---

## Utiliser les fonctions d'économie d'énergie :

### FONCTION DÉTECTION AUTOMATIQUE D'OUVERTURE/FERMETURE DE FENÊTRES

Pour utiliser cette fonction, nous vous conseillons de régler votre radiateur sur les modes ,  ou . Cette fonction vient en complément de la programmation.

La fonction détection automatique d'aération  va détecter l'ouverture et la fermeture de vos fenêtres. L'appareil va automatiquement passer en mode Hors Gel  (7°C) lorsqu'il détectera une fenêtre ouverte, et remonter à la température de consigne, lorsqu'il détectera sa fermeture.

Nous vous déconseillons l'usage de la fonction détection automatique d'aération  dans les couloirs et pièces situées à proximité d'une porte d'entrée donnant sur l'extérieur ou dans le garage.





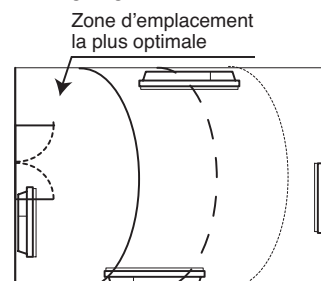

Votre radiateur réagit aux ouvertures et fermetures de fenêtre, en fonction de plusieurs variables, dont notamment :

- température souhaitée dans la pièce,
- température extérieure,
- configuration de votre installation (emplacement de votre radiateur par rapport à la fenêtre).

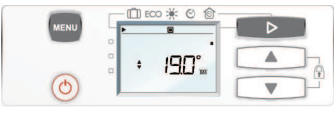
En détectant l'ouverture et la fermeture de la fenêtre, la fonction Aération vous permet d'adopter naturellement un geste éco-citoyen : ne pas chauffer inutilement votre logement lorsque vous l'aérez, pour plus de confort et d'économies.

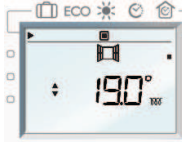



## Comment activer ou désactiver cette fonction ?

<p>Pour accéder à la fonction détection automatique d'aération, appuyez une fois sur .</p>		
<p>Pour activer la fonction, sélectionner OUI avec ▲ ou ▼ (D).</p>		 <p>Le picto détection automatique d'aération s'affiche.</p>
<p>Pour désactiver la fonction, sélectionner NON avec ▲ ou ▼ (D).</p>		 <p>Le mode en cours s'affiche et la fenêtre disparaît</p>
<p>Pour sortir du réglage, appuyez plusieurs fois sur la touche .</p>		

La température de fonctionnement est de 7° C, pendant toute la durée d'aération de votre pièce. A la fermeture de la fenêtre, votre radiateur reprendra son fonctionnement initial.

**La durée maximum d'aération prévue est de 2 heures. Après 2 heures, le radiateur se remet en chauffe dans tous les cas.**

**NB :** Si la fonction ne satisfait pas à votre besoin, vous pouvez arrêter manuellement la chauffe de votre radiateur pendant la durée de l'aération (appui sur la touche Mise en arrêt chauffage  ou  (suivant modèle).

## FONCTION INDICATEUR DE CONSOMMATION

La consommation d'un appareil de chauffage électrique dépend, entre autre, de la température demandée. La température préconisée par les pouvoirs publics est de 19° C en mode Confort (15,5° C en mode Eco).

La fonction "indicateur de consommation" vous permet de vous positionner par rapport à cette température recommandée.

Ainsi, en fonction de la température demandée :

- Si le repère noir de l'écran se positionne devant le 2ème pictogramme orange ou le rouge, vous aurez un comportement plus responsable en abaissant significativement votre température demandée.

- Si le repère noir de l'écran se positionne devant le 1er pictogramme orange, vous aurez un comportement plus responsable en abaissant légèrement votre température demandée.

- Si le repère noir est devant le pictogramme vert, vous êtes à la température recommandée et vous avez d'ores et déjà un comportement responsable.



## VERROUILLER LES COMMANDES

Afin d'éviter toutes manipulations intempestives du boîtier de commande par les enfants, nous vous conseillons de le verrouiller.

### Comment verrouiller les commandes ?

Pour verrouiller les commandes, maintenez appuyé simultanément quelques secondes ▲ et ▼ (D).



Un cadenas s'affiche à l'écran : il n'est plus possible de modifier les réglages

### Comment déverrouiller les commandes ?

Pour déverrouiller les commandes, maintenez appuyé simultanément et quelques secondes ▲ et ▼ (D).



Le cadenas disparaît de l'écran : les réglages peuvent être modifiés.

## Réglages avancés

### TEMPÉRATURE MAXI : T° MAX

Votre appareil vous donne la possibilité d'enregistrer une température maxi que vous ne pourrez pas dépasser lorsque vous serez en mode Confort. La plage est comprise entre 19°C et 28°C.

Maintenez appuyé simultanément et quelques secondes **MENU** et ▲, t° MAX 28°C s'affiche.



Réglez la température maxi de votre choix en appuyant sur ▲ ou ▼ (D).  
Après 5 secondes d'inactivité la température est validée automatiquement.

Pour sortir de cette fonction, appuyez simultanément et quelques secondes les touches **MENU** et ▲.



L'affichage revient au mode en cours.

### ÉTALONNER LA TEMPÉRATURE

Après plusieurs heures de chauffe, il est possible, en fonction de votre installation, que vous releviez une température différente de celle affichée sur votre radiateur. Dans ce cas, vous pouvez étalonner le radiateur pour ajuster la température.

La valeur d'étalonnage est comprise entre -2°C et +2°C.

Maintenez appuyé simultanément et quelques secondes **MENU** et ▲, puis appuyez 1 fois sur ►, t° OFFSET s'affiche.





Réglez la différence de température en appuyant sur ▲ ou ▼ (D).  
Après 5 secondes d'inactivité la température est validée automatiquement.

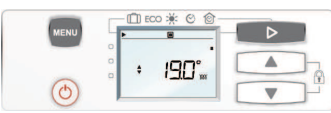

<p>Pour sortir de cette fonction, appuyez simultanément et quelques secondes <b>MENU</b> et ▲.</p>		<p>L'affichage revient au mode en cours.</p>
--	---	--

## BRIDER LES RÉGLAGES

Vous pouvez brider les réglages de votre radiateur et ainsi rendre inaccessible les changements de modes de fonctionnement et les menus. La mise en marche/veille, le réglage de la température de consigne, le verrouillage des commandes et les réglages avancés restent accessibles.

<p>Pour brider le réglage, maintenez appuyés simultanément et quelques secondes <b>MENU</b> et ▲. Appuyez sur ► jusqu'à ce que «br non» s'affiche.</p>		<p>Appuyez sur ▲ ou ▼ pour sélectionner OUI. Attendez 5 secondes. Pour sortir de cette fonction, appuyez en même temps, quelques secondes sur <b>MENU</b> et sur ▲. Les réglages sont figés (la température de consigne du mode en cours reste modifiable).</p>
<p>Tous les affichages apparaissent à l'écran.</p>		<p>Après une minute d'inactivité ou en appuyant simultanément et quelques secondes sur <b>MENU</b> et ▲, l'appareil se met en mode Confort à 19°C. Le mode ECO est à 15,5°C. Les fonctions d'économie d'énergie et les programmations sont désactivées.</p>

## ENREGISTRER UN CODE D'ACCÈS

Vous pouvez enregistrer un code personnel d'accès aux réglages avancés afin de contrôler l'accès aux fonctions : «Enregistrer une température maxi», «Ajuster la température», «Brider les réglages».

<p>Pour enregistrer un code d'accès, maintenez appuyé en même temps et quelques secondes <b>MENU</b> et ▲. Appuyez sur ► jusqu'à ce que «CP non» s'affiche.</p>		<p>Appuyez sur ▲ ou ▼ pour sélectionner OUI. Attendez 5 secondes. Quand votre code est saisi, attendez 5 secondes. Pour sortir de cette fonction, appuyez en même temps, quelques secondes sur <b>MENU</b> et ▲. L'accès aux réglages avancés est codé.</p>
---	---	---

Notez ici votre code d'accès personnel :

<p>Pour accéder aux réglages avancés, maintenez appuyé en même temps et quelques secondes <b>MENU</b> et ▲.</p>		<p>Appuyez sur ▲ ou ▼ pour saisir votre code. Attendez 5 secondes. Vous avez accès aux réglages avancés.</p>
---	---	--

<p>Pour désactiver le code d'accès, retournez dans les réglages avancés en appuyant en même temps, quelques secondes sur <b>MENU</b> et <b>▲</b>.</p> <p>Saisissez votre code. Attendez 5 secondes. Appuyez sur <b>▶</b> jusqu'à ce «CP» et votre code s'affichent.</p>		<p>Appuyez sur <b>▲</b> ou <b>▼</b> jusqu'à ce que « non » s'affiche (entre 000 et 999). Attendez 5 secondes.</p> <p>Pour sortir de cette fonction, appuyez en même temps, quelques secondes sur <b>MENU</b> et sur <b>▲</b>. L'accès aux réglages avancés n'est plus codé.</p>
---	---	---

## RETOUR AU RÉGLAGE DE BASE USINE

Votre appareil vous offre la possibilité de revenir au réglage de base (température recommandée, programmation initiale).

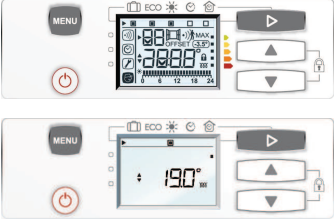
<p>Maintenez appuyé simultanément et quelques secondes sur <b>MENU</b> et <b>▲</b>, puis appuyez 3 fois sur <b>▶</b> (C). Pour activer la fonction, sélectionnez OUI avec <b>▲</b> ou <b>▼</b> (D).</p>		<p>« ru » « non » s'affiche à l'écran. Appuyez sur <b>▲</b> ou <b>▼</b> (D), sélectionnez « oui ».</p> <p>Après 5 secondes d'inactivité, votre réglage est validé automatiquement.</p>
<p>Tous les affichages apparaissent à l'écran.</p>		<p>Après une minute d'inactivité ou en appuyant simultanément et quelques secondes sur <b>MENU</b> et <b>▲</b>, l'appareil se met en mode Confort à 19°C. Le mode ECO est à 15,5°C. Les fonctions d'économie d'énergie et les programmations sont désactivées.</p>

## LE DÉLESTAGE

Nos appareils sont compatibles avec différents systèmes de délestage. Vous ne devez toutefois pas utiliser de délestage par coupure d'alimentation secteur car ce système est incompatible avec nos appareils. Il détériore le thermostat.

Lors des périodes de délestage, votre radiateur affiche « dEL ». Il revient ensuite à son mode de fonctionnement initial.

## ENTRETIEN

Pour conserver les performances de l'appareil, il est nécessaire environ deux fois par an d'effectuer à l'aide d'un aspirateur ou d'une brosse le dépoussiérage des entrées et sorties d'air. Tous les cinq ans, faire vérifier l'intérieur de l'appareil par un professionnel. La carrosserie de l'appareil peut être nettoyée avec un chiffon humide. Ne jamais utiliser de produits abrasifs ou de solvants.

## EN CAS DE PROBLÈME

Problèmes rencontrés	Vérification à faire
Le radiateur ne chauffe pas	Vérifiez que le mode Confort ☀ est bien activé. Si vous êtes en programmation, vérifiez que le programmeur est en mode CONFORT. Assurez-vous que les disjoncteurs de l'installation sont enclenchés ou bien que le délesteur (si vous en avez un) n'a pas coupé l'alimentation du radiateur. Vérifiez la température de l'air de la pièce : si elle est trop élevée, le pictogramme de chauffe ne s'allume pas : le radiateur ne chauffe pas.
Le radiateur chauffe tout le temps.	Vérifiez que le radiateur n'est pas situé dans un courant d'air ou que le réglage de la température n'a pas été modifié.
Le radiateur ne chauffe pas assez	Augmentez la température de consigne Confort. Si le réglage est au maximum, faites les vérifications suivantes : - Vérifiez si un autre mode de chauffage existe dans la pièce. - Assurez-vous que votre radiateur ne chauffe que la pièce (porte fermée). - Faites vérifier la tension d'alimentation de l'appareil. - Vérifiez si la puissance de votre radiateur est adaptée à la taille de votre pièce (nous vous préconisons en moyenne 100W/m <sup>2</sup> pour une hauteur de plafond de 2,50 m).
Le pictogramme de chauffe ☀ clignote	La sonde est débranchée ou ne fonctionne pas. Contactez votre installateur.
Des traces de salissures apparaissent sur le mur autour du radiateur	Les salissures sont liées à la mauvaise qualité de l'air ambiant. Il est conseillé, dans ce cas de vérifier la bonne aération de la pièce (ventilation, entrée d'air, etc...), et la propreté de l'air, et d'éviter de fumer à l'intérieur. Ces salissures ne justifient pas le remplacement sous garantie de l'appareil.
Le pictogramme de chauffe ☀ apparaît sur l'écran lorsque le radiateur est en mode ECO.	Ce fonctionnement est normal. Le radiateur peut chauffer de manière à maintenir une température Eco.
Le radiateur chauffe alors que la fenêtre est ouverte.	Il peut y avoir un laps de temps entre l'ouverture de la fenêtre et l'arrêt de la chauffe. Si ce laps de temps vous paraît trop long, vous pouvez arrêter manuellement la chauffe du radiateur.
Pour les appareils équipés d'un système de programmation ou piloté par l'intermédiaire du fil pilote.	
Le radiateur ne suit pas les ordres de programmation externes.	Assurez-vous de la bonne utilisation de la centrale de programmation (voir notice d'utilisation). Vérifiez que le fil pilote soit bien connecté à la centrale. Vérifiez que votre appareil est en mode Programme et que le programme externe « Centralisée » est attribué au jour souhaité de la semaine.
Le radiateur est très chaud en surface	Il est normal que le radiateur soit chaud lorsqu'il fonctionne, la température maximale de surface étant limitée conformément à la norme NF Electricité Performance. Si toutefois vous jugez que votre radiateur est toujours trop chaud, vérifiez que la puissance est adaptée à la surface de votre pièce (nous vous préconisons 100W / m <sup>2</sup> pour une hauteur sous plafond de 2,50 m) et que le radiateur n'est pas placé dans un courant d'air qui perturberait sa régulation.
Il y a une différence significative entre la température ambiante de la pièce et la température de consigne de l'appareil.	Il est nécessaire d'attendre 6 heures au minimum pour que la température se stabilise. Il est possible, en fonction de votre installation, que vous releviez une température différente de celle affichée sur votre radiateur. Dans ce cas, vous pouvez étalonner la température affichée. Reportez-vous au paragraphe « Etalonner la température » page 16.



Thank you for making this choice and for your confidence in our product. The radiator that you have just bought has been subjected to various tests and inspections in order to provide high quality and to ensure that it will bring you entire satisfaction.  
It will enable you to heat your room and to economise on energy consumption.

EN

**Please take the time to read these instructions in order to understand better how to install your radiator and to use the advice contained in the instructions to improve your wellbeing. Make sure to keep the instructions, even after installing the radiator.**

## Table of Contents

(RMGD-MK21 / RMGDV-MK21)

<b>Warning</b> .....	22
<b>Identify the radiator serial numbers</b> .....	22
<b>Installation</b> .....	23
Prepare the radiator installation .....	23
Fix the wall bracket to the wall .....	24
Connect the radiator .....	25
Installing the device on its wall bracket .....	27
<b>Operation</b> .....	27
Control box .....	27
The various displays .....	27
The various heating options .....	28
<b>First Use</b> .....	28
Switch the device on .....	28
Putting the device on stand-by .....	29
Set the time and the day .....	29
<b>Use of modes</b> .....	30
Heat your room: use the comfort mode .....	30
Going out for a few hours: use the eco mode .....	31
Going away more than 48 hours: use of the frost free mode .....	32
Programme your heating period: use internal programming mode .....	32
Program your heating period: use the centralised programming mode .....	34
<b>Use the energy economy functions:</b> .....	34
Automatic ventilation detection function .....	34
Consumption indicator function .....	35
Lock the controls .....	35
<b>Installer Mode</b> .....	36
Maximum temperature: t°max .....	36
Calibrate the temperature .....	36
Lock settings .....	37
Record an access code .....	37
Returning to the factory setting .....	38
Shedding .....	38
Maintenance .....	38
In case of problem .....	39

## Warning



- Caution: hot surface.

### **CAUTION :**

**Certain parts of this product can become very hot and cause burning. Particular attention should be given in the presence of children and vulnerable people.**

Children between 3 and 8 years should only put the unit on or off, to provided that the latter has been placed or installed in a normal position and that these children have supervision or have received instructions on using the machine safely and understand the potential hazards.

Children aged between 3 and 8 years must not connect or adjust or clean the device and perform maintenance or user.

This unit can be used by older children at least 8 years and by people with physical, sensory or mental capabilities or lack of experience or knowledge, they (if ) is monitored correctly ( s) or instructions for using the appliance safely given to them and if the risks were apprehended.

Children should not play with the appliance. Cleaning and maintenance by the user should not be performed by children without supervision.



- In order to avoid overheating and for reasons of safety, do not cover the heating device.

The user instructions for this device are available on the web site or by contacting the after-sales department.

## Identify the radiator serial numbers

They are located on the left-hand side of the device.

The commercial Code and the Serial Number identify the manufacturer of the radiator which you have just bought.

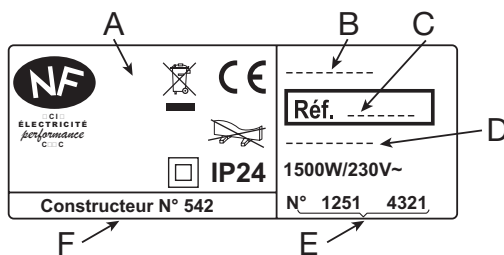

A Standards, quality labels

B Commercial name

**C Commercial Number**

D Manufacturer's number

**E Serial number**

F Manufacturer's number



Devices equipped with this symbol must not be discarded with household waste, but must be collected separately and recycled. The collection and the recycling of products at the end of their lifetime must be carried out in accordance with the local by-laws and provisions.

### Specifications of the radiator:

CAT C : A device satisfying the standard NF Electricity Performance in accordance with the criteria of the category indicated.

IP24 : Device protected against penetration of foreign solid bodies and water splashes.

Classe II : Double insulation (*no connection to earth*).

## Installation

### PREPARE THE RADIATOR INSTALLATION

- This device has been designed to be installed in residential premises. In all other cases, please consult your dealer.
- The installation must be done in accordance with the rules of the trade and in conformity with standards in force in the country of installation (NFC 15100 for France).
- If you have a wall covering installed on foam, a wedge must be put under the device support of a thickness equal to that of the foam in order to maintain a free space behind so as not to disturb its regulation.

#### Do not install the device:

- **In a draught which is likely to disturb its regulation (subject to a Centralised Mechanical Ventilation system, etc).**
- **Under a fixed current socket.**
- **In volume 1 in bathrooms.**

Devices used in bathrooms must be installed in such a manner that the switches and the other control devices of the device cannot be touched by a person in the bathroom or the shower.

- Respect the minimum distances with the furniture for the placing of the device.

**Horizontal Model**

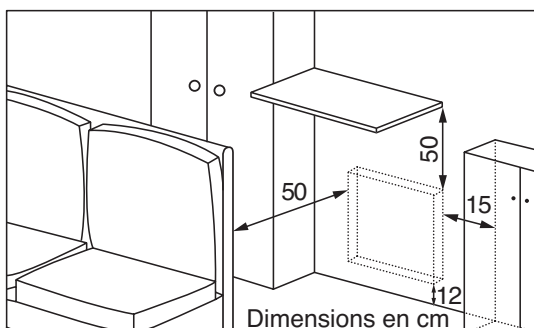

**Vertical Model**

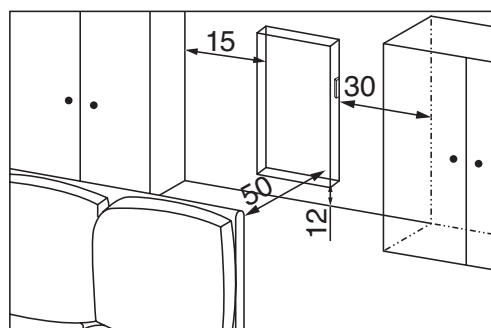

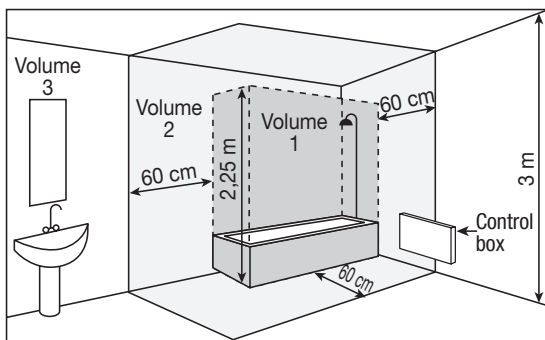

<b>Volume 1</b>	No electrical equipment
<b>Volume 2</b>	Electrical equipment Class II – IPX4
<b>Volume 3</b>	Electrical equipment Class II



## FIX THE WALL BRACKET TO THE WALL

### Horizontal Model

<b>1</b>	<p style="text-align: center;">Drilling points A</p>	<b>2</b>	<p style="text-align: center;">Drilling points B</p> <p style="text-align: center;">Drilling points A</p>
	<p>Fix the wall bracket to the floor and against the wall. Identify the drilling points A. These give the position of the lower fixings.</p>		<p>Move the wall support up, causing the points previously identified with the drilling holes A to coincide. Mark the 2 drilling points B using a ball point pen. You have thus identified the 4 drilling points.</p>
<b>3</b>	<p>Drill the 4 holes and put appropriate raw plugs in your wall (e.g. plaster board, concrete). Position the bracket and screw it in.</p>		



## Vertical Model

<b>1</b>		<b>2</b>	
	<p>Fix the wall bracket to the floor and against the wall. Identify the drilling points A. These give the position of the lower fixings.</p>		<p>Move the wall support up, causing the points previously identified with the drilling holes A to coincide. Mark the 2 drilling points B using a ball point pen.</p>
<b>3</b>	<p>Drill the 4 holes and put appropriate raw plugs in your wall (e.g. plaster board, concrete). Position the bracket and screw it in.</p>		

## CONNECT THE RADIATOR

- The radiator must be supplied with 230 V Single-phase 50Hz.
- The supply to the device must be directly connected to the network after the omni-pole cut-off device with a contact opening distance of at least 3mm without any intermediate switch (clock, mechanical relay and static relay, ambient thermostat, etc...).
- Connecting to the network will be done using a 3 wire cable (Brown = Phase, Blue = Neutral, Black = Pilot wire) via the intermediary of a connection box. In humid locations such as kitchens and bathrooms, the connection box must be installed at least 25 cm from the ground.
- The installation must be equipped with a protection device of circuit-breaker type.

### **Connection to earth is forbidden.**

### **Do not connect the pilot wire (black wire) of the device to earth.**

- If the supply cable is damaged, it must be replaced by the manufacturer, by its after-sales service or by a person of similar qualifications in order to avoid danger.

- If the pilot or piloted device is protected by a 30mA differential (e.g.: bathroom), it is necessary to protect the supply of the pilot wire on that differential.
- If you want to use a shedder, this must not cut-off the electrical supply to the radiators since there is incompatibility with these radiators. This will damage the thermostat.

### Radiator connection schematic

Switch off the current and connect the wires in accordance with the following:

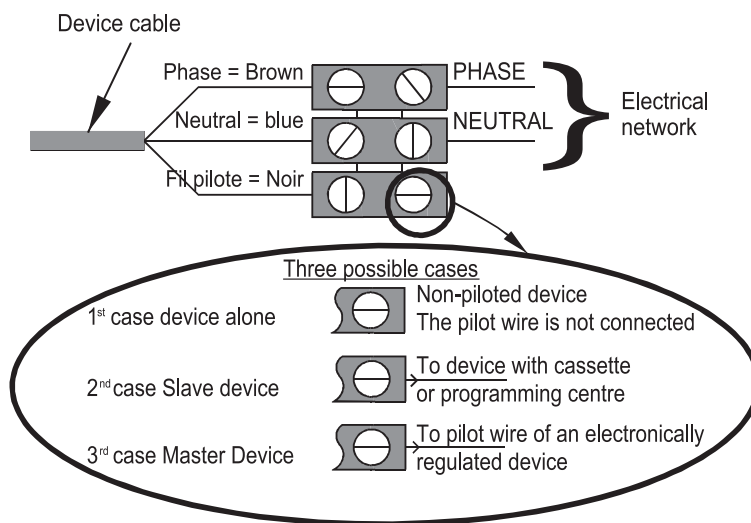

### Pilot wire connection test

You can connect the pilot wire if your house is equipped with a programming centre, a programmer or a manager.

In this case, to check the correct transmission of the programming orders, proceed with the following checks:

Orders received	Signal to be transmitted	Mode obtained
Absence of current	—	COMFORT
230v during 3s	⚡	COMFORT -1°C
230v during 7s	⚡	COMFORT -2°C
230V	Ⓢ	ECO
-115V negative	Ⓜ	FROST FREE
+115V positive	Ⓜ	STOPPING HEATING SHEDDING

## INSTALLING THE DEVICE ON ITS WALL BRACKET

- Install the device on the bracket S in accordance with the drawing
- Move the device towards the bracket and then lift it (arrow 1 and 2)
- Introduce the bracket lugs into the holes in the device, move it down (arrow 3).
- Lock it by turning the 2 V locks a half turn, your device is now fixed

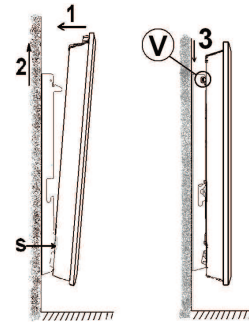

## Operation

### Control box

For more comfort and economy, your device is equipped with a digital display control box. It enables you to set all the functions of the radiator.

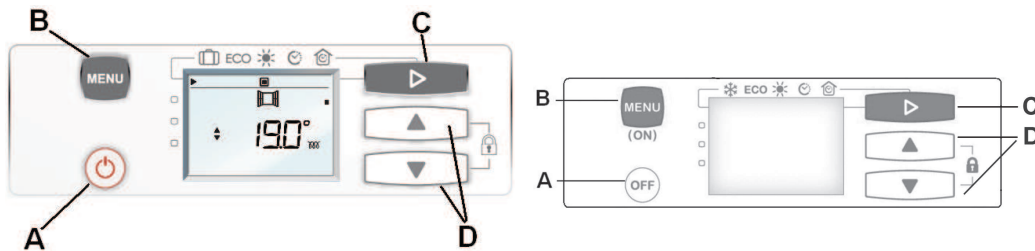

- A Switching on /putting on stand-by
- B Programming / Settings
- C Selection of heating modes
- D Setting buttons



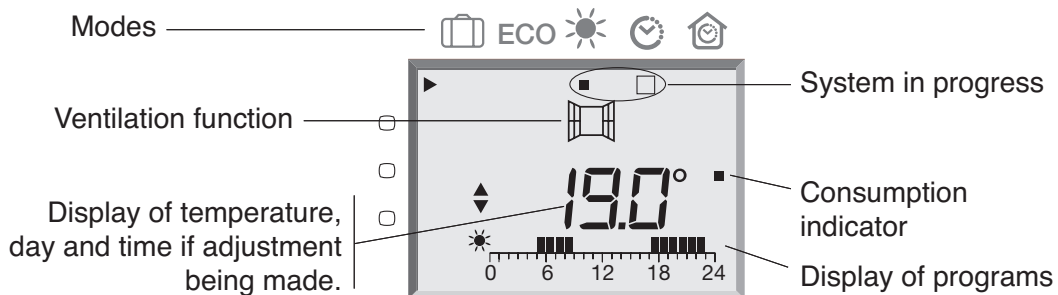

- A Switch off heating
- B Switch on/ Internal programming settings
- C Mode selection
- D Adjustment

### The various displays





After 2 minutes of non-activity, the screen returns to the current display

## THE VARIOUS HEATING OPTIONS



Pictogram	Description	When to use this mode?
	Comfort	You are in the house.
<b>ECO</b>	Eco	You are absent for 2 to 48h or you are sleeping.
	Frost free	You are absent more than 48h or it is summer. The Frost Free temperature is fixed at 7°C approximately and cannot be modified.
	Internal programming	You want your radiator to follow the programming orders. You can change one of the five programmes proposed by pressing twice on the MENU button (B). Refer to page 11 for detailed explanations.
	Centralised programming	These heating modes are accessible only in case of the presence of a centralised programming system (using the Pilot Wire) on your installation.

### First Use

## SWITCH THE DEVICE ON

<p>To switch the device on, press the switch on button (A)</p>	 	<div style="text-align: center;">  </div> <p>The device displays the comfort temperature. When first switched on, the device is set in Comfort mode at 19°C.</p>
--	--	---

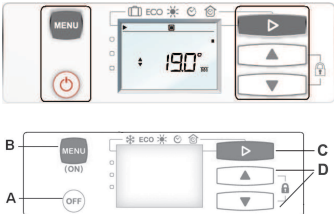





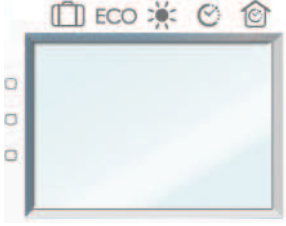



## Activate the screen

<p>If the screen is not on, press on any key to reactivate the screen display</p>		<div style="text-align: center;">  </div> <p>You can now press on the button corresponding to the setting that you want to fix.</p>
---	---	---

## PUTTING THE DEVICE ON STAND-BY

<p>Put the device on stand-by, hold the stand-by button (A) pressed for some time.</p>		<div style="text-align: center;">  </div> <p style="text-align: center;">The screen goes out.</p>
--	---	--

## SET THE TIME AND THE DAY



<p>To have access to the time and the day, press several times on the Menu (B) button until the spinner is selected </p>		<div style="text-align: center;">  </div> <p>The letters on the screen are displayed: you can start setting the time.</p>
<p>To modify the time, press on ▲ or ▼ (D), the times flash. Press again on ▲ or ▼ (D) to change the time.</p>		<div style="text-align: center;">  </div> <p>After 5s of non-activity, the time is set automatically and the minutes flash.</p>
<p>After setting the times, you can have access to setting the minutes by pressing on ▲ or ▼ (D)</p>		<div style="text-align: center;">  </div> <p>After 5s of non-activity, the minutes are automatically validated.</p>
<p>After setting the hours /minutes, you can have access to the setting of the day by pressing on ► (C).</p>		<div style="text-align: center;">  </div> <p>The letters on the screen are displayed, you can start setting the day.</p>
<p>To change the day, press on ▲ or ▼ (D), the day flashes. Press again on ▲ or ▼ (D) to change the day.</p>		<div style="text-align: center;">  </div> <p>After 5s of non-activity the day is automatically validated.</p>

## Use of modes

### HEAT YOUR ROOM: USE THE COMFORT MODE



This mode enables you to have the desired ambient temperature in the room. The consumption indicator lights enable your setting to be optimised (see on page 30).

#### How to activate the comfort mode?

<p>To activate the Comfort mode, press several times on ► (C) until the cursor is on the Comfort mode ☀.</p>		 <p>By default, the Comfort temperature is at 19°C.</p>
--	---	--



The recommended Comfort temperature is 19° C.  
The Comfort mode goes from 12.5° C to 28° C.

#### How to modify the desired temperature?

<p>To modify the displayed temperature, press on ▲ or ▼ (D), the temperature flashes. Press again on ▲ or ▼ (D) to change the temperature.</p>		 <p>The heating indicator ⌘ appears on the screen if the ambient temperature is less than that displayed. After 5s of non-activity, the temperature is validated.</p>
--	---	--













It needs at least 6 hours for the temperature to be stabilised in the room.

<p>If the room temperature is not convenient, press on ▲ or ▼ (D), the temperature flashes. Press again on ▲ or ▼ (D) to adjust the temperature.</p>		 <p>The higher the temperature indicated on the screen, the more the consumption indicator will move downwards (orange and red indicator)</p>
--	---	--

**GOING OUT FOR A FEW HOURS: USE THE ECO MODE**

You are recommended to use this mode for periods of absence of between 2 hours and 48 hours, or during the night, notably in bedrooms.  
 The maximum ECO temperature is 19°C or 0.5°C less than the comfort temperature.

<p>To activate the ECO mode, press several times on ► (C) until the cursor is on the ECO mode.</p>		 <p>By default, the ECO temperature is at 15.5°C.</p>
--	--	---

	Comfort display	Eco display
<p>Changing from Comfort mode to ECO mode: temperature falls by -3.5°C compared to the Comfort temperature.</p>		
<p>The pictogram -3.5°C does not appear on the screen: the divergence from the set Comfort temperature, is different by -3,5°C.</p>		
<p>If you lower the Comfort temperature below the Eco temperature, the Eco temperature will automatically lower by -0,5°C compared to the Comfort temperature.</p>		
<p>Increase the Comfort temperature, the Eco temperature does not change.</p>		



## How to modify the desired temperature?

If you so desire, you can modify the temperature displayed by pressing on ▲ or ▼ (D), the temperature flashes. Press again on ▲ or ▼ (D) to make the temperature change.



After 5s of non-activity, the ECO temperature is automatically validated.

## GOING AWAY MORE THAN 48 HOURS: USE OF THE FROST FREE MODE

To activate the Frost Free mode , press several times on ► (C) until the cursor is on the Frost free mode .



The Frost Free temperature  is preset to 7° C ( $\pm 3^\circ$  C) and cannot be modified.

## PROGRAMME YOUR HEATING PERIOD: USE INTERNAL PROGRAMMING MODE

Before setting the programming, the timing must be set on the radiator or you must make sure that it is already at the right day and time.

### Description

You can program your Comfort temperature periods  and ECO periods by using one of the 5 preset programmes.

5 programmes are preset: P1, P2, P3, P4 and P5 and cannot be modified.

	0h	1h	2h	3h	4h	5h	6h	7h	8h	9h	10h	11h	12h	13h	14h	15h	16h	17h	18h	19h	20h	21h	22h	23h
P1																								
P2																								
P3																								
P4																								
P5																								

**P1** is preset for constant presence, for example over the weekend (ECO mode from 0 h to 10 h, Comfort mode from 10 h to 0 h).

**P2** is preset if you are absent during the day (ECO mode from 0 h to 6 h and from 9 h to 17 h, Comfort mode from 5 h to 9 h and from 17 h to 23 h).

**P3** is preset if you are absent during the day, but that you come home at noon (ECO mode from 23 h to 5 h, from 9 h to 12 h and from 14 h to 17 h, Comfort mode from 5 h to 9 h, from 12 h to 14 h and from 17 h to 23 h).

**P4** Permanent comfort.

**P5** Permanent Eco.



### How to set a daily programme?

To have access to the daily programme, press on **MENU** until the picto 



For 01 (Monday), the default programme is P1.

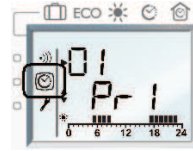

### Retain the selected programme?

If you want to retain the programme P1 on Monday: press on **▶** (C) to pass to the next day.



02 (Tuesday) is displayed on the screen with the P1 programme by default.

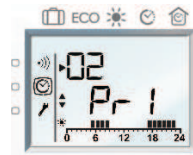

### Change the selected programme?

If you want to modify the Monday programme: press on **▲** or **▼** (D) to pass to the following programme. Select the desired programme.



01 (Monday) is displayed on the screen with the chosen programme. The programme flashes and after 5s of non-activity, the chosen programme is automatically validated.



### Set a daily programme for all the days in the week

You proceed in the same manner for all the days in the week, until Sunday, while retaining the selected programme, or by modifying it.

### How to activate the internal programming?

To activate the Internal programming, press on **▶** (C) and select .



The internal programming picto and the current setting in accordance with the chosen programme is displayed on the screen.







## PROGRAM YOUR HEATING PERIOD: USE THE CENTRALISED PROGRAMMING MODE

Before setting the programming, the time must be set on the radiator or you must make sure that it is already at the correct day and time.

 Corresponds to the use of a centralised programmer.



**NB :** In case there is no command on the pilot wire, the radiator operates in Comfort mode.  
When changing from the Comfort mode to the ECO mode, the changing time is about 12 seconds.  
The Frost Free and Shedding commands take priority compared to the Eco and Comfort modes.

### How to activate centralised programming?



<p>To activate Centralised programming, press several times on  until the cursor is on the Centralised programming mode .</p>		<div style="text-align: center;">  </div> <p>The centralised programming picto and the current setting is displayed on the screen.</p>
---	---	---

## Use the energy economy functions:

### AUTOMATIC VENTILATION DETECTION FUNCTION

To use this function, we recommend you to set your radiator on modes ,  or .

This function is a supplement to the programming.

The automatic ventilation detection function  will detect the opening and the closing of the windows. The device will automatically change to Frost Free  (7°C) when it detects an open window and will restart at the set temperature, when it detects that it is closed.

We do not recommend the use of an automatic ventilation detection function  in corridors and rooms located next to an entry door giving onto the outside or onto the garage.







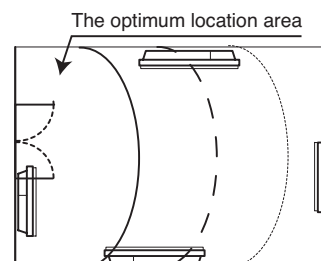

Your radiator reacts to opening and closing of windows, in accordance with several variables, including in particular:

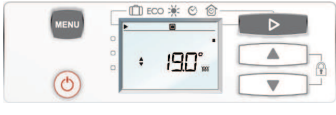
- the desired temperature in the room,
- external temperature,
- configuration of your installation (the location of your radiator in relation to the window).

By detecting the opening and closing of the window, the Ventilation function enables you to adopt a natural eco-citizen position: not to heat your dwelling needlessly when you are ventilating it, for more comfort and economy.



## How to activate or deactivate this function?

<p>To get access to the automatic ventilation detection function, press once on .</p>		
<p>To activate the function, select "on" with  or  (D).</p>		<p>The automatic ventilation detection picto is displayed.</p>
<p>To de-activate the function, select "OFF" with  or  (D).</p>		<p>The current mode is displayed and the window icon disappears</p>
<p>To leave the fixing area, press several times on .</p>		

The operating temperature is 7° C, during the entire ventilation duration of your room. When the window closes, your radiator will restart its initial operation.

**The maximum duration of ventilation provided is 2 hours. After 2 hours, the radiator will start heating again in all cases.**

**NB :** If the function does not meet your needs, you can manually stop the heating of your radiator during the duration of ventilation (press on the Stand-by key (A) .

## CONSUMPTION INDICATOR FUNCTION

The consumption of an electrical heating device depends, among others, on the required temperature. The temperature recommended by the authorities is 19° C in Comfort mode (15.5° C in ECO mode).

The "consumption indicator" function enables you to position yourself compared to this recommended temperature.

In this way, depending on the required temperature:

- If the black identification on the screen is positioned in front of the 2nd orange or red pictogram, you will have a more responsible behaviour by significantly lowering your required temperature.
- If the black identification on the screen is positioned on the 1st orange pictogram, you will have a more responsible behaviour by slightly lowering your required temperature.

- If the black identification is in front of the green pictogram, you have the recommended temperature and, as from now on, you show responsible behaviour.



## LOCK THE CONTROLS

In order to avoid any unexpected handling of the control box by children, we recommend you to lock it.

### How to lock the controls?

To lock the controls, hold the ▲ and ▼ (D) pressed simultaneously for a few seconds.



A padlock is displayed on the screen: it is not possible to modify the settings

### How to unlock the controls?

To unlock the controls, hold ▲ or ▼ (D) pressed simultaneously for a few seconds.



The padlock disappears from the screen: the settings can be modified.

## Installer Mode

### MAXIMUM TEMPERATURE: T° MAX

Your device gives you the possibility of setting a maximum temperature that you cannot exceed when you are in Comfort mode. The range is between 19°C and 28°C.

Hold the buttons **MENU** and ▲ pressed simultaneously for a few seconds, t° MAX 28°C is displayed.



Set the maximum temperature of your choice by pressing on ▲ or ▼.  
After 5 seconds on one activity, the temperature is automatically validated.

To de-activate this function, press simultaneously for a few seconds on **MENU** and ▲.



The display returns to the current mode.



### CALIBRATE THE TEMPERATURE

After a few hours of heating, it is possible, depending on your installation, that you will find a different temperature from that displayed on your radiator. In this case, you can calibrate the radiator to adjust the temperature. The calibration value is between -2°C and +2°C.

Hold **MENU** and ▲ simultaneously pressed for a few seconds then press 1 time on ► (C), t° OFFSET is displayed.



















Set the temperature difference by pressing ▲ or ▼.  
After 5 seconds of non-activity the temperature is automatically validated.

<p>To leave this function, press  and  simultaneously for a few seconds.</p>		<p>The display returns to the current mode.</p>
--	---	---









## LOCK SETTINGS

You can lock the settings for your radiator and so block access to changes made to operating modes and menus. Switching on/standby, the set-point temperature setting, command locking and advanced settings remain accessible.





<p>To lock the setting, hold  and  pressed together for a few seconds. Hold  pressed until «br non» is displayed.</p>		<p>Press  or  to select YES. Wait for 5 seconds. To exit this function, hold  and  pressed together for a few seconds. The settings are locked (the set-point temperature for the current mode remains modifiable).</p>
<p>To de-activate this function, hold  and  pressed together for a few seconds. Hold  pressed until «br oui» is displayed.</p>		<p>Press  or  to select NO. Wait for 5 seconds. To exit this function, hold  and  pressed together for a few seconds. The settings are locked (the set-point temperature for the current mode remains modifiable).</p>

## RECORD AN ACCESS CODE

You can record a personal access code to the advanced settings, so as to restrict access to functions: «Set a maximum temperature», «Adjust the temperature», «Lock the settings».

<p>To record an access code, hold  and  pressed together for a few seconds. Press  until «CP non» is displayed.</p>		<p>Press  or  to enter your code. Attendre 5 secondes. Once your code is entered, wait for 5 seconds. To exit this function, hold  and  pressed together. Access to advanced settings is coded.</p>
--	---	---



Note your personal access code here:

<p>To access advanced settings, hold  and  pressed together for a few seconds.</p>		<p>Press  or  to enter your code. Wait 5 seconds. You have access to the advanced settings.</p>
--	---	---

<p>To de-activate the access code, go back to advanced settings and hold <b>MENU</b> and <b>▲</b> pressed together for a few seconds. Enter your code. Wait 5 seconds. Press <b>▶</b> until «CP» and your code are displayed.</p>		<p>Hold <b>▲</b> or <b>▼</b> pressed until «no» is displayed (between 000 and 999). Wait 5 seconds. To exit this function, hold <b>MENU</b> and <b>▲</b> pressed together for a few seconds. Access to the advanced settings is no longer coded.</p>
---	---	--

## RETURNING TO THE FACTORY SETTING

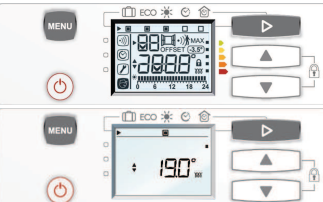
Your device gives you the possibility of returning to the basic setting (recommended temperature, initial programming).

<p>Hold <b>MENU</b> and <b>▲</b> pressed simultaneously for a few seconds, then press 3 times on <b>▶</b> (C). To activate the function, select OUI with the setting buttons <b>▲</b> or <b>▼</b> (D).</p>		<p>“FS” “OFF” is displayed on the screen. Press on <b>▲</b> or <b>▼</b> (D), select “on”. After 5 seconds of non-activity, your setting is automatically validated.</p>
<p>All the settings appear on the screen.</p>		<p>After 1 minute of non-activity or by pressing simultaneously on <b>MENU</b> and <b>▲</b>, the device is put onto the Comfort mode  at 19°C. The ECO mode is at 15.5°C. The energy economy functions and the programming are de-activated.</p>



## SHEDDING

Our devices are compatible with the various shedding systems. However you cannot use shedding by cutting off the network supply since this system is incompatible with our devices. It damages the thermostat. During shedding periods, your radiator displays “Off”. It then comes back to its initial operating mode.

## MAINTENANCE

To retain the performance of the device, it is necessary about twice a year to carry out dust removal using a vacuum cleaner or a brush at the air inlets and outlets. Every five years, have the inside of the device checked by a professional electrician. The outside of the device can be cleaned with a damp cloth. Never use abrasive products or solvents

## IN CASE OF PROBLEM

Problems encountered	Checks to be made
The radiator does not heat	Check that the Comfort mode  is indeed activated. If you are in programming, check that the programmer is in Comfort mode. Make sure that the installation circuit breakers are engaged or that the shedder (if you have one) has not cut off the supply to the radiator. Check the air temperature in the room: if it is too high, the heat pictogram will not display: the radiator will not heat.
The radiator heats all the time.	Check that the radiator is not located in a draught or that the setting of the temperature has not been modified.
The radiator does not heat enough	Increase the temperature of the Comfort setting. If the setting is at maximum, make the following checks: - Check if another heating method exists in the room. - Make sure that your radiator is only heating that room (close the door). - Make sure that the device supply voltage is present. - Check that the power of your radiator is suitable for the size of your room (we recommend on average 100W/m <sup>2</sup> with a ceiling height of 2.50 m).
The heating pictogram  flashes	The detector is disconnected or does not work. Contact your installer.
Traces of dirt appear on the wall around the radiator	Dirt is connected with the bad quality of the ambient air. You are recommended in this case to check the correct ventilation of the room (ventilation, air entry, etc...), and the cleanliness of the air, and to avoid smoking inside. This dirt does not justify the replacement under guarantee of the device.
The heating pictogram  appears on the screen when the radiator is in ECO mode.	This operation is normal. The radiator can heat in such a manner as to maintain an Eco temperature.
The radiator heats when the window is open.	There can be a lapse of time between the opening of the window and the stopping of the heating. If this lapse of time appears too long to you, you can manually stop the heating of the radiator.
For devices equipped with a programming system or piloted by the intermediary of the pilot wire.	
The radiator does not follow external programming orders.	Make sure of the correct use of the programming centre (see instruction for use). Check that the pilot wire is indeed connected to the centre. Check that your device is not in Programme mode and that the external programme "Centralised" is attributed on the required day of the week.
The radiator is very hot on its surface	It is normal that the radiator is hot when it operates, the maximum surface temperature being limited in conformity with the Electricity Performance standard NF. If however you find that your radiator is always too hot, check that the power is suitable for the area of your room (we recommend 100W / m <sup>2</sup> for a height under ceiling of 2.50 m) and that the radiator is not located in a draught which can disturb its regulation.
There is a significant difference between the ambient temperature in the room and the set temperature of the device.	It is necessary to wait 6 hours minimum for the temperature to stabilise. It is possible, depending on your installation, that you will find a different temperature from that displayed on your radiator. In this case, you can calibrate the displayed temperature. Refer to the paragraph "Calibrate the temperature" on page 31.





Queremos felicitarle por su compra y agradecerle la confianza que nos ha depositado. El radiador que acaba de adquirir ha pasado por numerosos tests y controles para garantizar su calidad y poder proporcionarle un uso satisfactorio.

Este radiador le permitirá calentar su estancia y a la vez obtener un ahorro energético.

ES

**Lea las instrucciones de uso atentamente para comprender mejor cómo funciona su radiador y conocer los consejos de uso para mejorar su bienestar.  
Conserve las instrucciones de uso, incluso después de instalar el radiador.**

## Índice

(RMGD-MK21 / RMGDV-MK21)

<b>Advertencias</b> .....	42
<b>Identificar las referencias del radiador</b> .....	42
<b>Instalación</b> .....	43
Preparar la instalación del radiador .....	43
Fijar el soporte mural a la pared .....	44
Conectar el radiador .....	45
Instalar el aparato en su soporte mural .....	47
<b>Funcionamiento</b> .....	47
<b>Panel de control</b> .....	47
<b>Indicaciones del panel de control</b> .....	47
Modos de calefacción .....	48
<b>Primera utilización</b> .....	48
Poner en marcha el aparato .....	48
Poner en espera el aparato .....	49
Ajustar la hora y día .....	49
<b>Utilización de los modos</b> .....	50
Calentar su estancia : utilización del modo confort .....	50
Ausentarse algunas horas: utilización del modo eco .....	51
Ausentarse más de 48 horas: utilización del modo anti-hielo .....	52
Programar el tiempo de calefacción : utilización del modo programación interna .....	52
Programar el tiempo de calefacción: utilización del modo programación centralizada .....	54
<b>Utilización de las funciones de ahorro energético:</b> .....	54
Función detección automática de ventilación .....	54
Función indicador de consumo .....	55
Bloqueo del panel de control .....	55
<b>Modo instalador</b> .....	56
Temperatura máxima : t° máx. ....	56
Calibrar la temperatura .....	56
Embridar los ajustes .....	57
Grabar un código de acceso .....	57
Restauración de los ajustes iniciales de fábrica .....	58
Protección de desconexión de carga .....	58
Mantenimiento y limpieza .....	58
En caso de problemas .....	59
	41

## Advertencias



- Atención, superficie muy caliente.

### ATENCIÓN:

**Algunas partes de este producto pueden calentarse mucho y provocar quemaduras. Se debe prestar una atención particular en presencia de niños y personas vulnerables.**

Los niños entre 3 y 8 años únicamente están autorizados a activar la unidad de encendido y de apagado ON-OFF a condición de que ésta última haya sido colocada o instalada en una posición normal prevista y siempre que éstos se encuentren bajo la supervisión de un adulto o hayan recibido adecuadamente las instrucciones relativas al uso del aparato de forma segura y siempre que los riesgos en que puedan incurrir hayan sido tomados en consideración.

Los niños entre 3 y 8 años no pueden conectar el aparato, ni ajustar o limpiar el dispositivo, ni llevar a cabo ninguna de las actividades de mantenimiento indicadas para el usuario.

Este dispositivo puede ser usado por niños a partir de 8 años y por personas cuyas capacidades físicas, sensoriales o mentales estén reducidas, o por personas sin la experiencia ni los conocimientos necesarios, siempre que estén bajo la supervisión de una persona responsable de su seguridad para su utilización. Es necesario evitar que los niños jueguen con este aparato. La limpieza y el mantenimiento del dispositivo no deberán ser realizados en ningún caso por niños sin supervisión.



- Para evitar el sobrecalentamiento y por motivos de seguridad, no cubra el aparato de calefacción.

Las instrucciones de uso de este aparato están disponibles en el sitio internet o puede ponerse en contacto con el servicio de postventa.

### Identificar las referencias del radiador

Están situadas en el lado izquierdo del aparato.

El código comercial y el número de serie es la referencia que utiliza el constructor del radiador que acaba de adquirir.

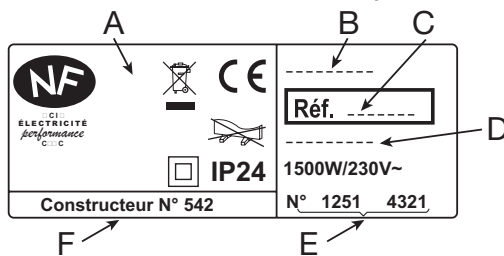

A Normas, sellos de calidad

B Denominación comercial

**C Referencia comercial**

D Referencia de fabricación

**E N° de serie**

F N° de constructor



Los aparatos que presentan este símbolo no deben tirarse a la basura doméstica, deben depositarse en un lugar de recogida especial para ser reciclados posteriormente.

La recogida y reciclaje de los productos al final de su vida útil debe realizarse de acuerdo con las disposiciones y decretos locales.

### Características del radiador:

CAT C : Aparato que respeta la norma NF Electricidad Rendimiento según los criterios de la categoría indicada.

IP24 : Aparato protegido contra la entrada de cuerpos sólidos externos y proyecciones de agua.

Clase II : Doble aislamiento (*sin conexión a tierra*).

## Instalación

### PREPARAR LA INSTALACIÓN DEL RADIADOR

- Este aparato se ha diseñado para instalarlo en un local residencial. En otros casos, consulte con su distribuidor.
- La instalación debe realizarse conforme a lo establecido y respetando las normas vigentes del país de instalación (NFC 15100 para Francia).
- Si dispone de un revestimiento mural colocado sobre espuma, debe introducir un espaciador bajo el soporte del aparato de un grosor igual al de la espuma para mantener un espacio libre en la parte trasera y no perturbar su regulación.

### No instalar el aparato:

- **En una corriente de aire susceptible de perturbar su regulación (bajo una ventilación mecánica centralizada, etc.).**
- **Bajo una toma de corriente fija.**
- **En el volumen 1 de los cuartos de baño.**

Los aparatos utilizados en cuartos de baño deben instalarse de manera que se imposibilite la manipulación de los interruptores y otros dispositivos de control del aparato por parte de una persona que se encuentre en la bañera o la ducha.

- Respetar las distancias mínimas con el mobiliario para la ubicación del aparato.

**Modelo Horizontal**

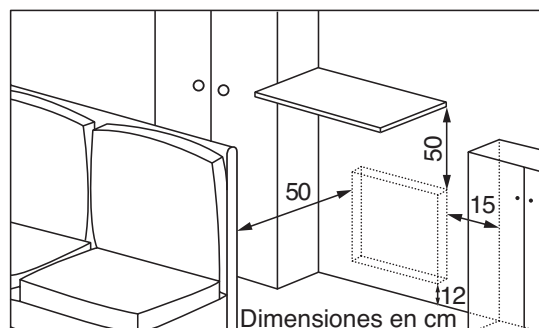

**Modelo Vertical**

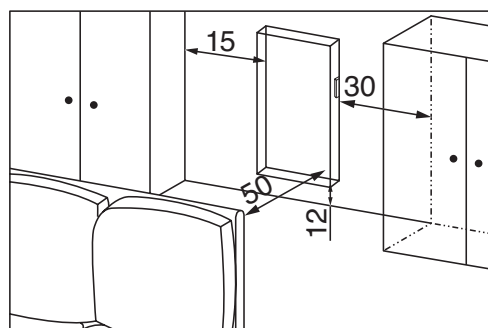

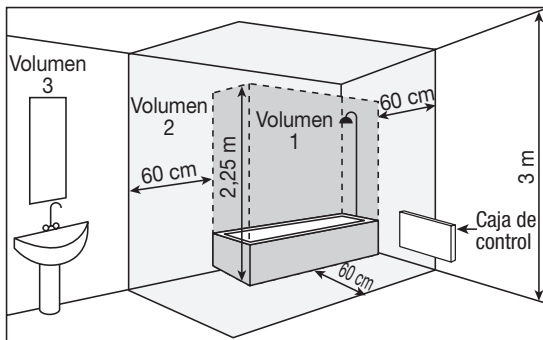

<b>Volumen 1</b>	Sin aparatos eléctricos
<b>Volumen 2</b>	Aparato eléctrico de clase II - IP X4
<b>Volumen 3</b>	Aparato eléctrico de clase II

## FIJAR EL SOPORTE MURAL A LA PARED

### Modelo Horizontal

<b>1</b>		<b>2</b>	
	<p>Coloque el soporte mural en el suelo y contra la pared. Identifique los puntos de perforación A. Éstos indican la posición de las fijaciones inferiores.</p>		<p>Suba el soporte mural haciendo que los puntos de perforación citados anteriormente coincidan con los agujeros de perforación A.          Marque los 2 puntos de perforación B mediante un bolígrafo. Debe tener los 4 puntos de perforación marcados.</p>
<b>3</b>	<p>Realice los 4 agujeros e introduzca los tacos adaptados a su pared (ej. yeso, hormigón, etc.). Coloque el soporte y atornille.</p>		

## Modelo Vertical

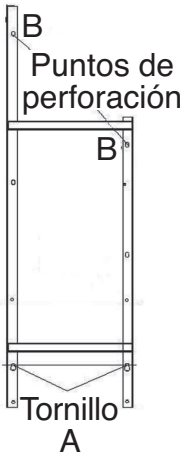
<b>1</b>		<b>2</b>	
	<p>Coloque el soporte mural en el suelo y contra la pared. Identifique los puntos de perforación A. Éstos indican la posición de las fijaciones inferiores.</p>	<b>2</b>	<p>Suba el soporte mural haciendo que los puntos de perforación citados anteriormente coincidan con los agujeros de perforación A. Marque los 2 puntos de perforación B mediante un bolígrafo.</p>
<b>3</b>	<p>Realice los 4 agujeros e introduzca los tacos adaptados a su pared (ej. yeso, hormigón, etc.). Coloque el soporte y atornille.</p>		

## CONECTAR EL RADIADOR

- El aparato debe tener un suministro eléctrico de 230 V monofásico 50 Hz.
- La conexión eléctrica debe realizarse mediante un dispositivo de corte omnipolar, con una distancia de separación de los polos de un mínimo de 3 mm sin interruptor intermedio (reloj, relé mecánico y estático, termostato de ambiente, etc.).
- La conexión a la red se realizará mediante un cable de 3 hilos (marrón = fase, azul = neutro, negro = hilo piloto) por medio de una caja de conexión. En estancias húmedas como cocinas y cuartos de baño, es necesario instalar la caja de conexión a una distancia mínima de 25 cm del suelo.
- La instalación debe incluir un dispositivo de protección tipo disyuntor.

**Queda prohibida la conexión a tierra.**

### No conectar el hilo piloto (hilo negro) del aparato a tierra.

- Si el cable de alimentación estuviera deteriorado, deberá ser sustituido por el fabricante, su servicio de postventa o una persona de cualificación similar, con el fin de evitar cualquier peligro.
- Si el aparato piloto o pilotado está protegido por un diferencial de 30 mA (ej.: cuarto de baño), es necesario proteger la alimentación del hilo piloto en este diferencial.
- Si quiere utilizar una protección de desconexión de carga, ésta no debe cortar el suministro eléctrico de los radiadores puesto que existe incompatibilidad con nuestros radiadores. Deterioraría el termostato.

### Esquema de conexión del radiador

Corte la electricidad y conecte los cables según el esquema siguiente:

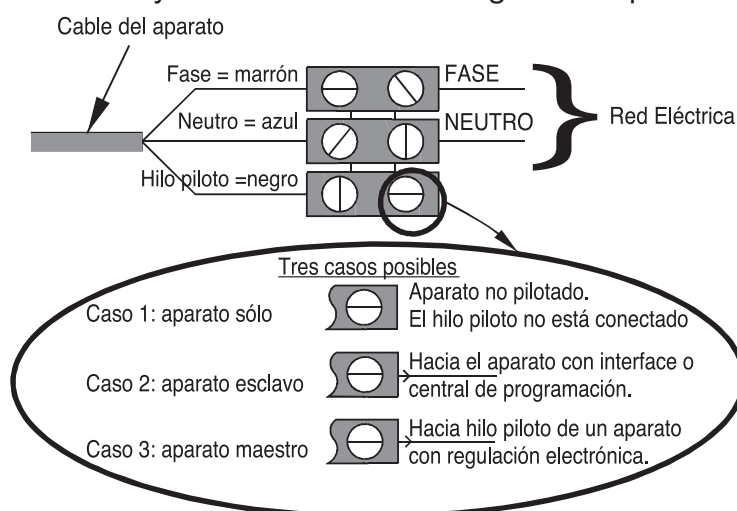

### Test de conexión del hilo piloto

Puede conectar el hilo piloto si su casa está equipada con una central de programación, un programador o un equipo gestor.

En dicho caso, para comprobar la correcta transmisión de las órdenes de programación, proceda a las comprobaciones siguientes:

Órdenes recibidas	Señal a transmitir	Modo obtenido
Ausencia de corriente	—	CONFORT
230 v durante 3 s	⚡	CONFORT -1°C
230 v durante 7 s	⚡	CONFORT -2°C
230V	~	ECO
-115 V negativo	⌒	ANTI-HIELO
+115 V positivo	⌒	DESCONEXIÓN DE CARGA

## INSTALAR EL APARATO EN SU SOPORTE MURAL

- Coloque el aparato en el soporte S según el esquema.
- Lleve el aparato hacia el soporte y súbalo (flecha 1 y 2).
- Introduzca las patas del soporte en los orificios del aparato, bájelo (flecha 3).
- Bloquee girando los 2 dispositivos de bloqueo V media vuelta, su aparato está fijado.

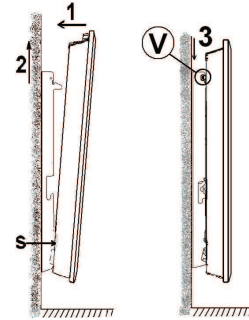

## Funcionamiento

### W•b•Á•b•Á•c•~•c~

Para mayor confort y ahorro, su equipo está dotado con un panel de control con visualización digital. Le permite ajustar todas las funciones del radiador.

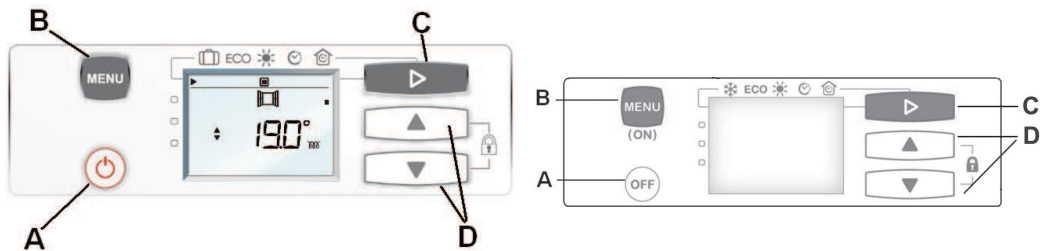

- A Puesta en marcha / Puesta en espera
- B Programación / Ajustes
- C Selección de los modos de calefacción
- D Teclas de ajuste



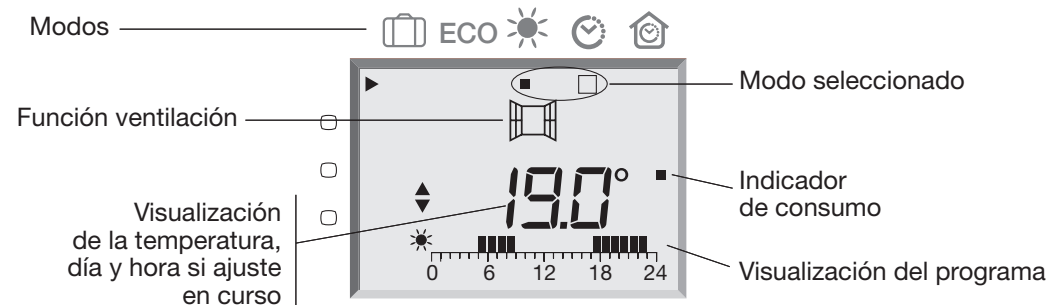

- A Parada de calefacción
- B Puesta en marcha/ Ajustes de la Programación interna
- C Selección de los modos
- D Ajuste

### Paño•c•b•Á•b•Á•c•~•c~Á





Tras 2 minutos de inactividad, la pantalla vuelve a la visualización en curso

## MODOS DE CALEFACCIÓN



Pictograma	Designación	¿Cuándo se utiliza este modo?
	Confort	Está en casa.
<b>ECO</b>	Eco	Está ausente de 2 a 48 h o duerme.
	Anti-hielo	Está ausente más de 48 h o es verano. La temperatura Anti-hielo está fijada a 7 °C aproximadamente y no se puede modificar.
	Programación interna	Si quiere que su radiador siga las órdenes de una programación, puede seleccionar uno de los cinco programas propuestos pulsando dos veces la tecla "MENU" (B). Véase pág. 11 para obtener información detallada.
	Programación centralizada	Estos modos de calefacción únicamente son accesibles en caso de presencia de un sistema de programación centralizada (por Hilo Piloto) en su instalación.

### Primera utilización

#### PONER EN MARCHA EL APARATO

<p>Para poner en marcha el aparato, pulse la tecla Puesta en marcha (A)</p>	 	 <p>El aparato indica la temperatura de confort. En la primera utilización, el aparato está programado en modo Confort a 19°C.</p>
---	---	---

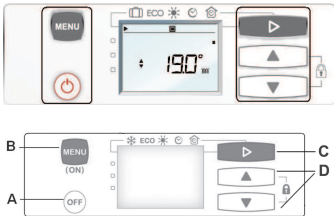
#### Activar la pantalla







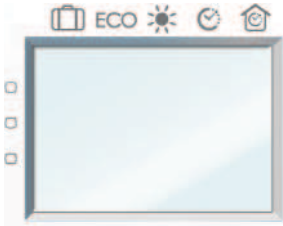



<p>Si la pantalla no está iluminada, pulse una tecla para reactivar la iluminación de la pantalla.</p>		 <p>Ya puede pulsar la tecla correspondiente al ajuste que desea realizar.</p>
--	---	--

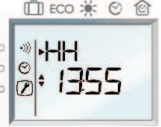

## PONER EN ESPERA EL APARATO

<p>Para poner en espera el aparato, mantenga pulsada la tecla Puesta en espera (A).</p>		 <p>La pantalla se apaga.</p>
---	---	--

## AJUSTAR LA HORA Y DÍA



<p>Para acceder al ajuste del día y de la hora, pulse varias veces la tecla "Menu" (B) hasta la selección de la llave </p>		 <p>En la pantalla aparecen las letras: puede comenzar el ajuste de la hora.</p>
<p>Para modificar la hora, pulse ▲ o ▼ (D), las horas parpadean. Vuelva a pulsar ▲ o ▼ (D) para cambiar la hora.</p>		 <p>Tras 5 segundos de inactividad la hora queda grabada automáticamente y los minutos parpadean.</p>
<p>Después de ajustar la hora, puede acceder al ajuste de los minutos pulsando ▲ o ▼ (D)</p>		 <p>Tras 5 segundos de inactividad los minutos quedan grabados automáticamente.</p>
<p>Después de ajustar la hora y los minutos, puede acceder al ajuste del día pulsando ► (C).</p>		 <p>En la pantalla aparecen las letras, puede comenzar el ajuste del día.</p>
<p>Para modificar el día, pulse ▲ o ▼ (D), el día parpadea. Vuelva a pulsar ▲ o ▼ (D) para cambiar el día.</p>		 <p>Tras 5 segundos de inactividad el día queda grabado automáticamente.</p>

## Utilización de los modos

### CALENTAR SU ESTANCIA : UTILIZACIÓN DEL MODO CONFORT



Este modo le permite obtener la temperatura ambiente deseada en la estancia. Los testigos del indicador de consumo le permitirán optimizar su ajuste (véase pág. 46).

#### ¿Cómo activar este modo?

<p>Para activar el modo Confort, pulse varias veces ► (C) hasta que el cursor esté en modo Confort ☀</p>		 <p>Por defecto, la temperatura Confort es de 19°C.</p>
--	---	--

La temperatura Confort recomendada es de 19° C.  
El modo Confort va de 12,5° C a 28° C.

#### ¿Cómo modificar la temperatura?

<p>Para modificar la temperatura visualizada, pulse ▲ o ▼ (D), la temperatura parpadea. Vuelva a pulsar ▲ o ▼ (D) para cambiar la temperatura.</p>		 <p>El testigo de calefacción ☀ aparece en la pantalla si la temperatura ambiente es inferior a la temperatura visualizada. Tras 5 segundos de inactividad la temperatura queda grabada.</p>
--	---	---



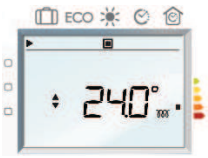

Es necesario un mínimo de 6 horas para que la temperatura se estabilice en la estancia.



<p>Si quiere cambiar la temperatura de la estancia, pulse ▲ o ▼ (D), la temperatura parpadea. Vuelva a pulsar ▲ o ▼ (D) para ajustar la temperatura.</p>		 <p>Cuanto más elevada sea la temperatura indicada en la pantalla, más abajo aparecerá el indicador de consumo (indicador naranja y rojo)</p>
--	---	--

### AUSENTARSE ALGUNAS HORAS: UTILIZACIÓN DEL MODO ECO

Se aconseja utilizar este modo para periodos de ausencias comprendidas entre 2 horas y 48 horas, o durante la noche, especialmente en los dormitorios.

La temperatura ECO máxima es de 19°C ó 0,5°C menos que la temperatura confort.

<p>Para activar el modo ECO, pulse varias veces ► (C) hasta que el cursor esté en modo ECO.</p>		 <p>Por defecto, la temperatura ECO es de 15,5°C.</p>
---	---	---

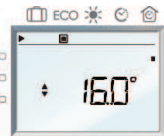
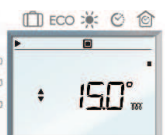
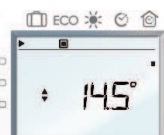
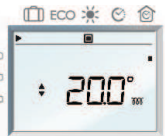
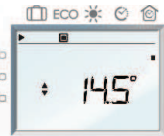
	Visualización Confort	Visualización ECO
<p>Cambio del modo Confort al modo ECO: temperatura de -3,5°C respecto a la temperatura Confort.</p>		
<p>El pictograma -3,5°C no aparece en la pantalla: la diferencia respecto a la temperatura Confort programada es de -3,5°C.</p>		
<p>Si baja la temperatura Confort por debajo de la temperatura ECO, la temperatura ECO bajará automáticamente de -0,5°C respecto a la temperatura Confort.</p>		
<p>Si aumenta la temperatura Confort, la temperatura ECO no cambia.</p>		

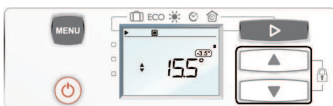

## ¿Cómo modificar la temperatura?

Si lo desea, puede cambiar la temperatura visualizada pulsando ▲ o ▼ (D), la temperatura parpadea. Vuelva a pulsar ▲ o ▼ (D) para cambiar la temperatura.



Tras 5 segundos de inactividad la temperatura ECO queda grabada automáticamente.

## AUSENTARSE MÁS DE 48 HORAS: UTILIZACIÓN DEL MODO ANTI-HIELO

Para activar el modo Anti-hielo , pulse varias veces ► (C) hasta que el cursor esté en modo Anti-hielo .



La temperatura Anti-hielo  está preconfigurada a 7° C ( $\pm 3^\circ$  C) y no se puede modificar.

## PROGRAMAR EL TIEMPO DE CALEFACCIÓN : UTILIZACIÓN DEL MODO PROGRAMACIÓN INTERNA

Antes de ajustar la programación, debe actualizar la hora del radiador o asegurarse de que la hora y día indicados son correctos.

### Descripción

Puede programar periodos de temperatura Confort  y ECO mediante uno de los cinco programas pregrabados.

Existen 5 programas pregrabados: P1, P2, P3, P4 y P5 y no modificables.

	0h	1h	2h	3h	4h	5h	6h	7h	8h	9h	10h	11h	12h	13h	14h	15h	16h	17h	18h	19h	20h	21h	22h	23h
P1																								
P2																								
P3																								
P4																								
P5																								

**P1** se aconseja para una presencia constante, por ejemplo, fines de semana (modo Eco de 0 h a 10 h, modo Confort de 10 h a 0 h).



**P2** se aconseja si está ausente durante el día (modo Eco de 0 h a 6 h y de 9 h a 17 h, modo Confort de 5 h a 9 h y de 17 h a 23 h).

**P3** se aconseja si está ausente durante el día, pero vuelve a mediodía (modo Eco de 23 h a 5 h, de 9 h a 12 h y de 14 h a 17 h, modo Confort de 5 h a 9 h, de 12 h a 14 h y de 17 h a 23 h).

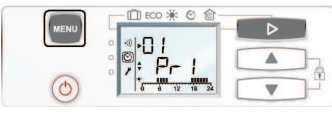

**P4** Confort permanente.

**P5** Eco permanente.

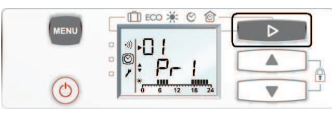

### ¿Cómo asignar un programa diario?

<p>Para acceder al programa diario, pulse <b>MENU</b> hasta el pictograma </p>		 <p>Para el lunes (01), el programa por defecto es P1.</p>
---	---	---

### ¿Cómo conservar el programa seleccionado?

<p>Si desea conservar el programa P1 del lunes: pulse <b>▶</b> (C) para pasar al día siguiente.</p>		 <p>02 (martes) aparece en la pantalla con el programa P1 por defecto.</p>
---	---	---



### ¿Cómo modificar el programa seleccionado?

<p>Si desea modificar el programa del lunes: pulse <b>▲</b> o <b>▼</b> (D) para pasar al programa siguiente. Seleccione el programa deseado.</p>		 <p>01 (lunes) aparece en la pantalla con el programa escogido. El programa parpadea y después de 5 segundos de inactividad, el programa escogido queda grabado automáticamente.</p>
--	---	---

### Asignar un programa diario a cada día de la semana

Proceda de la misma manera para todos los días de la semana, hasta el domingo, conservando el programa seleccionado o modificándolo.

### ¿Cómo activar la programación interna?

<p>Para activar la Programación interna, pulse <b>▶</b> (C) y seleccione </p>		 <p>En la pantalla aparece el pictograma Programación interna y la marcha en curso según el programa escogido.</p>
--	---	---

## PROGRAMAR EL TIEMPO DE CALEFACCIÓN: UTILIZACIÓN DEL MODO PROGRAMACIÓN CENTRALIZADA

Antes de ajustar la programación, debe actualizar la hora del radiador o asegurarse de que la hora y día indicados son correctos.



 corresponde al uso de un programador centralizado.

**NB :** En caso de ausencia de orden en el hilo piloto, el radiador funciona en modo Confort.

El cambio del modo Confort a modo ECO tarda unos 12 segundos.

Las órdenes Anti-hielo y Desconexión de carga son prioritarias respecto a los modos Eco y Confort.

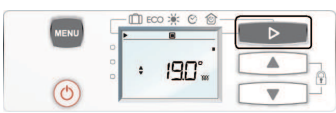
### ¿Cómo activar la programación centralizada?



<p>Para activar la Programación centralizada, pulse varias veces ► (C) hasta que el cursor esté en el modo Programación centralizada .</p>		 <p>En la pantalla aparece el pictograma Programación centralizada y la marcha en curso.</p>
--	--	---

## Utilización de las funciones de ahorro energético:

### FUNCIÓN DETECCIÓN AUTOMÁTICA DE VENTILACIÓN

Para utilizar esta función, le aconsejamos ajustar su radiador en los modos ,  o .

Esta función es un complemento de la programación.

La función detección automática de ventilación  detectará la abertura y cierre de sus ventanas. El aparato pasará automáticamente a modo Anti-hielo  (7°C) cuando detecte una ventana abierta, y volverá a aumentar a la temperatura indicada cuando detecte su cierre.

Le desaconsejamos el uso de la función Detección automática de ventilación  en pasillos y estancias situadas cerca de una puerta de entrada que dé al exterior o en el garaje.





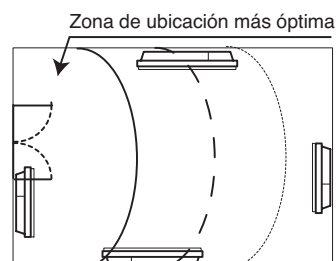

Su radiador reacciona a las aberturas y cierres de ventana en función de diversas variables, como, entre otras:

- temperatura deseada en la estancia,
- temperatura exterior,
- configuración de su instalación (ubicación de su radiador respecto a la ventana).

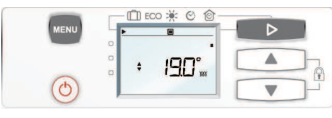
Gracias a la detección de una ventana abierta o cerrada, la función Ventilación le permite adoptar una actitud ecológica: no calentar inútilmente su estancia mientras la esté ventilando, para mayor confort y ahorro.

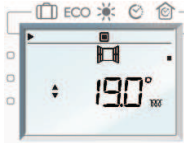

## ¿Cómo activar o desactivar esta función?

<p>Para acceder a la función Detección automática de ventilación, pulse una vez .</p>		
<p>Para activar la función, seleccione "on" con ▲ o ▼ (D).</p>		<p>En la pantalla aparece el pictograma Detección automática de ventilación.</p> 
<p>Para desactivar la función, seleccione "off" con ▲ o ▼ (D).</p>		<p>Aparece el modo en curso y la ventana desaparece.</p> 
<p>Para abandonar el ajuste, pulse varias veces .</p>		

La temperatura de funcionamiento es de 7° C durante todo el periodo de ventilación de su estancia. Al cerrar la ventana su radiador retomará su funcionamiento inicial.

**La duración máxima de ventilación prevista es de 2 horas. Después de 2 horas, el radiador vuelve a calentar de todas formas.**

**Nota:** Si no desea utilizar esta función, también puede parar manualmente el calentamiento de su radiador durante la duración de la ventilación (pulse la tecla Puesta en espera (A) .

## FUNCIÓN INDICADOR DE CONSUMO

El consumo de un aparato de calefacción eléctrico depende, entre otros, de la temperatura solicitada. La temperatura recomendada por las autoridades públicas es de 19° C en modo Confort (15,5° C en modo Eco). La función Indicador de consumo le permite situarse dentro de esta temperatura recomendada.

Así pues, en función de la temperatura solicitada:

- Si la marca negra de la pantalla se sitúa delante del segundo pictograma naranja o el rojo, adoptará una actitud más responsable bajando significativamente la temperatura seleccionada.
- Si la marca negra de la pantalla se sitúa delante del primer pictograma naranja, adoptará una actitud más responsable bajando ligeramente la temperatura seleccionada.
- Si la marca negra está delante del pictograma verde, significa que respeta la temperatura recomendada y ya ha adoptado una actitud responsable.



## BLOQUEO DEL PANEL DE CONTROL

Para evitar que los niños manipulen el panel de control, le aconsejamos que proceda a su bloqueo.

### ¿Cómo bloquear el panel de control

Para bloquear el panel de control, mantenga pulsados simultáneamente unos segundos ▲ y ▼ (D).



En la pantalla aparece un candado: ya no se pueden modificar los ajustes

### ¿Cómo desbloquear el panel de control?

Para desbloquear el panel de control, mantenga pulsados simultáneamente unos segundos ▲ y ▼ (D).



El candado desaparece de la pantalla: se pueden modificar los ajustes.

## Modo instalador

### TEMPERATURA MÁXIMA : T° MÁX.

Su aparato le ofrece la posibilidad de seleccionar una temperatura máxima que no podrá superar cuando esté en modo Confort. El rango está comprendido entre 19°C y 28°C.

Mantenga pulsadas simultáneamente durante unos segundos las teclas **MENU** y ▲, en la pantalla aparece "t° MAX 28°C".



Ajuste la temperatura máxima que desee pulsando ▲ o ▼. Tras 5 segundos de inactividad, la temperatura se graba automáticamente.

Para desactivar esta función, pulse simultáneamente durante unos segundos las teclas **MENU** y ▲.



La visualización vuelve al modo en curso.

### CALIBRAR LA TEMPERATURA



Tras varias horas de funcionamiento es posible que, dependiendo de su instalación, note una temperatura diferente a la que indica su radiador. En este caso, puede calibrar el radiador para ajustar la temperatura. El valor de calibrado está comprendido entre -2°C y +2°C.

Mantenga pulsadas simultáneamente durante unos segundos **MENU** y ▲, a continuación, pulse 1 vez ►, a continuación, pulse 1 vez (C), en la pantalla aparece « t° OFFSET ».



















Ajuste la diferencia de temperatura pulsando ▲ o ▼. Tras 5 segundos de inactividad, la temperatura se graba automáticamente.



<p>Para desactivar esta función, pulse simultáneamente durante unos segundos  y .</p>		<p>La visualización vuelve al modo en curso.</p>
---	---	--

## EMBRIDAR LOS AJUSTES

Puede embridar los ajustes de su radiador y de este modo volver inaccesible los cambios de los modos de funcionamiento y de los menús. La puesta en marcha/vigilia, el ajuste de la temperatura de consigna, el bloqueo de los mandos y los ajustes avanzados siguen siendo accesibles.













<p>Para embridar el ajuste, mantenga pulsado simultáneamente y unos segundos  y . Pulse  hasta que aparezca «br non».</p>		<p>Pulse  o  para seleccionar OUI. Espera 5 segundos. Para salir de esta función, pulse simultáneamente, durante unos segundos  y . Los ajustes se fijan (la temperatura de consigna del modo en curso sigue siendo modificable).</p>
<p>Para embridar el ajuste, mantenga pulsado simultáneamente y unos segundos  y . Pulse  hasta que aparezca «br oui».</p>		<p>Pulse  o  para seleccionar NON. Espera 5 segundos. Para salir de esta función, pulse simultáneamente, durante unos segundos  y . Los ajustes se fijan (la temperatura de consigna del modo en curso sigue siendo modificable).</p>

## GRABAR UN CÓDIGO DE ACCESO

Puede grabar un código personal de acceso a los ajustes avanzados con el fin de controlar el acceso a las funciones: «Grabar una temperatura máxima», «Ajustar la temperatura», «Embridar los ajustes».











<p>Para grabar un código de acceso, mantenga pulsado simultáneamente y durante unos segundos  y  pressed together for a few seconds. Pulse  hasta que aparezca «CP non».</p>		<p>Pulse  o  para introducir su código. Cuando introduzca su código, espere 5 segundos. Para salir de esta función, pulse simultáneamente, durante unos segundos  y . El acceso a los ajustes avanzados está codificado.</p>
---	---	--

Anote aquí su código de acceso personal:

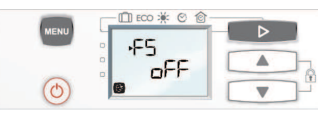
<p>Para acceder a los ajustes avanzados, mantenga pulsado simultáneamente y durante unos segundos  y .</p>		<p>Pulse  o  para introducir su código. Espere 5 segundos. Tiene acceso a los ajustes avanzados.</p>
<p>Para desactivar el código de acceso, regrese a los ajustes avanzados pulsando simultáneamente, durante unos segundos  y . Introduzca su código. Espere 5 segundos. Pulse  hasta que aparezca «CP» y su código.</p>		<p>Pulse  o  hasta que aparezca « non » (entre 000 y 999). Espere 5 segundos. Para salir de esta función, pulse simultáneamente, durante unos segundos  y . El acceso a los ajustes avanzados ya no está codificado.</p>

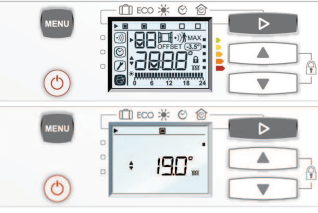
## RESTAURACIÓN DE LOS AJUSTES INICIALES DE FÁBRICA

Su aparato le ofrece la posibilidad de volver a los ajustes iniciales (temperatura recomendada, programación inicial).

<p>Mantenga pulsadas simultáneamente durante unos segundos  y , a continuación, pulse 3 veces  (C). Para activar la función, seleccione OUI con las teclas de ajuste  o  (D).</p>		<p>En la pantalla aparece “FS” “oFF”. Pulse  o  (D), seleccione “on”. Tras 5 segundos de inactividad, su orden se graba automáticamente.</p>
<p>La pantalla muestra todas las visualizaciones.</p>		<p>Tras un minuto de inactividad o pulsando simultáneamente durante unos segundos  y , el aparato pasa a modo Confort  a 19°C. El modo ECO es de 15,5°C. Las funciones de ahorro de energía y las programaciones están desactivadas.</p>

## PROTECCIÓN DE DESCONEXIÓN DE CARGA

Nuestros aparatos son compatibles con diferentes sistemas de desconexión de carga. Sin embargo, no debe utilizar ningún sistema de desconexión de carga mediante corte de electricidad porque este sistema no es compatible con nuestros aparatos. Deterioraría el termostato.



En periodos de desconexión de carga, su radiador indica “Off”. Seguidamente vuelve a su modo de funcionamiento inicial.

## MANTENIMIENTO Y LIMPIEZA

Para mantener la eficacia del aparato, es necesario quitar el polvo de las entradas y salidas de aire con una aspiradora o un cepillo unas dos veces al año. Cada cinco años debe confiar la revisión interior del aparato a un profesional. Puede limpiar la carrocería del aparato con un trapo húmedo.

No utilice nunca productos abrasivos o disolventes.

## EN CASO DE PROBLEMAS

Problemas detectados	Comprobaciones
El radiador no calienta	<p>Compruebe que el modo Confort  está correctamente activado. Si está en programación, compruebe que el programador está en modo CONFORT.</p> <p>Compruebe que los disyuntores de la instalación están armados o que el dispositivo de desconexión de carga (si tiene uno) no ha cortado el suministro de electricidad del radiador.</p> <p>Compruebe la temperatura del aire de la estancia: si es demasiado alta, el pictograma de calefacción no se enciende: el radiador no calienta.</p>
El radiador calienta constantemente.	Compruebe que el radiador no esté situado en una corriente de aire o que no se ha modificado el ajuste de la temperatura.
El radiador no calienta suficientemente	<p>Aumente la temperatura de consigna Confort.</p> <p>Si el ajuste está al máximo, proceda a las comprobaciones siguientes:</p> <ul style="list-style-type: none"> <li>- Compruebe si hay otro modo de calefacción en la estancia.</li> <li>- Compruebe que su radiador sólo calienta la estancia (puerta cerrada).</li> <li>- Haga comprobar el voltaje del aparato.</li> <li>- Compruebe que la potencia de su radiador está adaptada a las dimensiones de su estancia (le aconsejamos una media de 100 W/m<sup>2</sup> para una altura de techo de 2,50 m).</li> </ul>
El pictograma de calefacción  parpadea	La sonda está desconectada o no funciona. Póngase en contacto con su instalador.
Aparecen manchas de suciedad en la pared alrededor del radiador	Las manchas están relacionadas con la mala calidad del aire ambiente. En este caso se aconseja comprobar la buena ventilación de la estancia (ventilación, entrada de aire, etc.), y la pureza del aire, y evitar fumar en el interior. Estas manchas no justifican la sustitución del aparato dentro de la garantía.
El pictograma de calefacción  aparece en la pantalla cuando el radiador está en modo ECO.	Este funcionamiento es normal. El radiador puede seguir calentando para mantener una temperatura Eco.
El radiador calienta aunque la ventana está abierta.	<p>Puede haber lapsos de tiempo entre la abertura de la ventana y la parada de la calefacción.</p> <p>Si este lapso de tiempo le parece demasiado largo, puede parar manualmente la calefacción del radiador.</p>
Para los aparatos equipados con un sistema de programación o pilotado mediante hilo piloto.	
El radiador no sigue las órdenes de programación externas.	<p>Compruebe la buena utilización de la central de programación (véanse instrucciones de uso). Compruebe que el hilo piloto esté bien conectado a la central.</p> <p>Compruebe que su aparato está en modo Programa y que el programa externo "Centralizado" está asignado al día deseado de la semana.</p>
El radiador está muy caliente en la superficie	Es normal que el radiador esté caliente durante su funcionamiento, la temperatura máxima de superficie está limitada según la norma NF Electricidad Rendimiento. Sin embargo, si considera que su radiador siempre está muy caliente, compruebe que la potencia está adaptada a la superficie de su estancia (recomendamos 100 W/m <sup>2</sup> para una altura de techo de 2,50 m) y que el radiador no está situado en una corriente de aire que perturbaría su regulación.
Existe una diferencia significativa entre la temperatura ambiente de la estancia y la temperatura de consigna del aparato.	Es necesario esperar un mínimo de 6 horas para que la temperatura se estabilice. Tras varias horas de funcionamiento es posible que, dependiendo de su instalación, note una temperatura diferente a la que indica su radiador. En este caso, puede calibrar la temperatura indicada. Véase el apartado "Calibrar la temperatura", página 47.



Agradecemos a sua escolha e a confiança manifestada. O aquecedor que acaba de adquirir foi submetido a numerosos testes e controlos a fim de assegurar a sua qualidade e oferecer-lhe uma satisfação total.

Ele permite-lhe aquecer o ambiente e realizar economias de energia.

PT

**Leia atentamente o folheto de instruções para entender melhor a utilização do seu aquecedor e descobrir os conselhos de utilização para melhorar o seu bem-estar. Guarde o folheto de instruções, mesmo depois da instalação do aquecedor.**

## Índice

(RMGD-MK21 / RMGDV-MK21)

<b>Cuidado</b> .....	62
<b>Identificar as referências do aquecedor</b> .....	62
<b>Instalação</b> .....	63
Preparar a instalação do aquecedor .....	63
Fixar o suporte na parede .....	64
Connect the radiator .....	65
Instalar o aquecedor sobre o suporte de parede .....	67
<b>Funcionamento</b> .....	67
A caixa de comando .....	67
As diferentes indicações no ecrã .....	67
Os diferentes modos de aquecimento .....	68
<b>Primeira utilização</b> .....	68
Colocar o aparelho em funcionamento .....	68
Colocar o aparelho em modo de espera .....	69
Ajustar a hora e o dia .....	69
<b>Utilização dos modos</b> .....	70
Aquecer o ambiente: utilização do modo conforto .....	70
Ausentar-se durante algumas horas: utilização do modo eco .....	71
Ausentar-se por mais de 48 horas: utilização do modo antigelo .....	72
Programar o seu período de aquecimento utilização do modo de programação interna .....	72
Programar o seu período de aquecimento: utilização do modo de programação centralizada .....	74
<b>Utilizar as funções de economia de energia:</b> .....	74
Função de deteção automática de ventilação .....	74
Função indicador de consumo .....	75
Bloquear os comandos .....	75
<b>Modo instalador</b> .....	76
Temperatura máxima: t°max .....	76
Calibrar a temperatura .....	76
Bloquear as configurações .....	77
Registrar um código de acesso .....	77
Repór a regulação básica de fábrica .....	78
A limitação de carga .....	78
Manutenção .....	78
Em caso de problemas .....	79

## Cuidado



- Atenção, superfície muito quente.

### ATENÇÃO:

**Determinadas partes deste produto podem ficar muito quentes e provocar queimaduras. Deve-se ter especial atenção na presença de crianças e de pessoas vulneráveis.**

AS crianças entre 3 e 8 anos unicamente poderão colocar o aparelho no modo ligado ou desligado, e desde que este último tenha sido colocado ou instalado na sua posição normal, e que estas crianças estiverem baixo supervisão ou tiverem recebido instruções sobre o uso do equipamento de forma segura e compreenderem os perigos potenciais.

Crianças com idade entre 3 e 8 anos não devem activar ou ajustar ou limpar o dispositivo e executar a manutenção do utilizador.

Este aparelho pode ser usado por crianças mais velhas de 8 anos e por pessoas com capacidades físicas, sensoriais ou mentais reduzidas ou pessoas com falta de experiência ou do conhecimento, sempre que estiverem baixo a supervisão de um adulto responsável pela segurança para a utilização do equipamento.

As crianças não devem brincar com o aparelho. A limpeza e a manutenção do utilizador não devem ser executadas por crianças sem supervisão.



- A fim de evitar um sobreaquecimento e por razões de segurança, não cobrir o aquecedor.

O manual de utilização deste aparelho está disponível no site ou junto do serviço de assistência pós-venda.

## Identificar as referências do aquecedor

Elas estão situadas na lateral esquerda do aparelho.

O código comercial e o número de série identificam o aquecedor que acaba de adquirir junto do construtor.

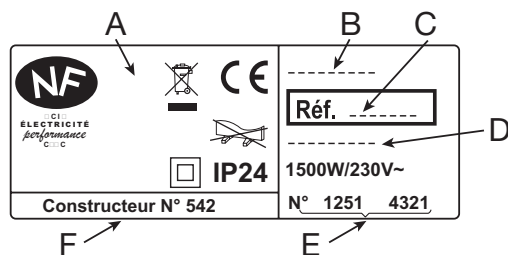

**A** Normas, selos de qualidade

**B** Nome comercial

**C** Referência comercial

**D** Referência de fabrico

**E** N.º de série

**F** N.º de construtor



Os aparelhos que apresentam este símbolo não devem ser eliminados com os resíduos domésticos, mas devem ser recolhidos separadamente e reciclados.

A recolha e a reciclagem dos produtos em fim de vida devem ser realizadas de acordo com as disposições e os decretos locais.

### Características do aquecedor:

CAT C : Aparelho respondendo à norma NF Eletricidade Desempenho, segundo os critérios da categoria indicada.

IP24 : Aparelho protegido contra as penetrações de corpos estranhos sólidos e projeções de água.

Classe II : Isolamento duplo (*sem ligação à terra*).

## Instalação

### PREPARAR A INSTALAÇÃO DO AQUECEDOR

- Este aparelho foi concebido para ser instalado num local residencial. Para qualquer outro caso, consulte o seu distribuidor.
- A instalação deve ser feita de acordo com as boas práticas, e em conformidade com as normas em vigor no país de instalação (NFC 15100 para a França).
- Se possui um revestimento de parede sobre espuma, deve colocar uma cunha da espessura da espuma sob o suporte do aparelho, a fim de conservar um espaço livre atrás para não perturbar a sua regulação.

### Não instalar o aparelho:

- Numa corrente de ar podendo perturbar a sua regulação (debaixo de uma Ventilação Mecânica Centralizada, entre outros).
- Debaixo de uma tomada elétrica fixa.
- No volume 1 em quartos de banho.

Os aparelhos utilizados em quartos de banho devem ser instalados de modo que os interruptores e outros dispositivos de comando do aparelho não possam ser tocados por uma pessoa na banheira ou no duche.

- Respeitar as distâncias mínimas dos móveis para instalar o aparelho.

**Modelo Horizontal**

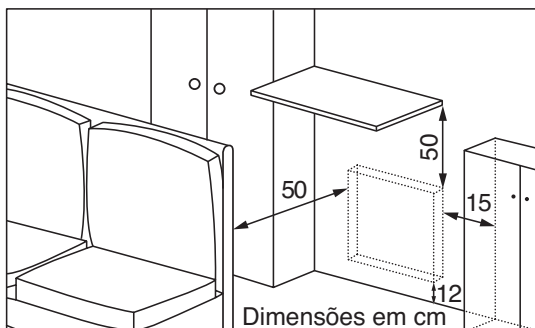

**Modelo Vertical**

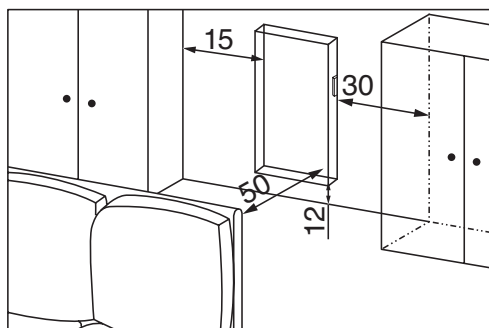

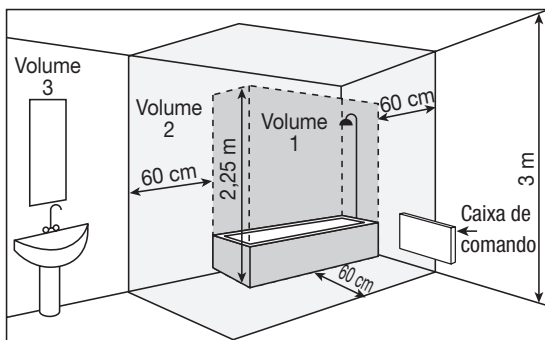

<b>Volume 1</b>	Nenhum aparelho elétrico
<b>Volume 2</b>	Aparelho elétrico Classe II – IP X4
<b>Volume 3</b>	Aparelho elétrico Classe II

## FIXAR O SUPORTE NA PAREDE

### Modelo Horizontal

<b>1</b>		<b>2</b>	
	<p>Coloque o suporte no chão, encostado na parede. Marque os pontos de perfuração A. Estes determinam a posição das fixações inferiores.</p>		<p>Suba o suporte, fazendo coincidir os pontos anteriormente marcados com os pontos de perfuração A. Marque os dois pontos de perfuração B com uma caneta. Os quatro pontos de perfuração estão marcados.</p>
<b>3</b>	<p>Faça os quatro furos e coloque as cavilhas apropriadas para a sua parede (ex.: placa de gesso, betão). Posicione o suporte e aparafuse.</p>		

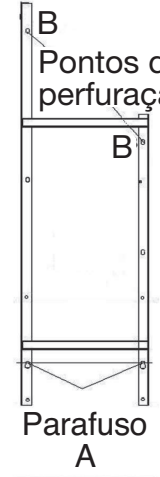

## Modelo Vertical

1		2	
	<p>Coloque o suporte no chão, encostado na parede. Marque os pontos de perfuração A. Estes determinam a posição das fixações inferiores.</p>		<p>Suba o suporte, fazendo coincidir os pontos anteriormente marcados com os pontos de perfuração A. Marque os dois pontos de perfuração B com uma caneta.</p>
3	<p>Faça os quatro furos e coloque as cavilhas apropriadas para a sua parede (ex.: placa de gesso, betão). Posicione o suporte e aparafuse.</p>		

## CONNECT THE RADIATOR

- O aparelho deve ser alimentado com 230 V monofásica 50 Hz.
- A alimentação do aquecedor deve ser diretamente ligada à rede após o dispositivo de corte onipolar com uma distância de abertura dos contactos de pelo menos 3 mm sem interruptor intermédio (relógio, relé mecânico e estático, termóstato ambiente, etc.).
- A ligação elétrica será realizada com um cabo de três fios (castanho = fase, azul = neutro, preto = fio piloto) através de uma caixa de ligação. Nos locais húmidos como as cozinhas e os quartos de banho, a caixa de ligação deve ser instalada a pelo menos 25 cm do chão.
- A instalação deve estar equipada com um dispositivo de proteção de tipo disjuntor.

### **A ligação à terra é proibida.**

### **Não ligar o fio piloto (fio preto) do aparelho à terra.**

- Se o cabo de alimentação estiver danificado, deve ser substituído pelo fabricante, o seu serviço de assistência pós-venda ou por um profissional com qualificação similar, a fim de evitar perigos.

- Se o aparelho piloto ou pilotado estiver protegido por um diferencial 30 mA (ex.: casa de banho), deve-se proteger a alimentação do fio piloto desse diferencial.
- Se utilizar um limitador de carga, este último não deve cortar a alimentação elétrica dos aquecedores porque existe incompatibilidade com os nossos aquecedores. Isso deterioraria o termóstato.

### Esquema de ligação do aquecedor

Corte a alimentação elétrica e ligue os fios de acordo com o seguinte esquema:

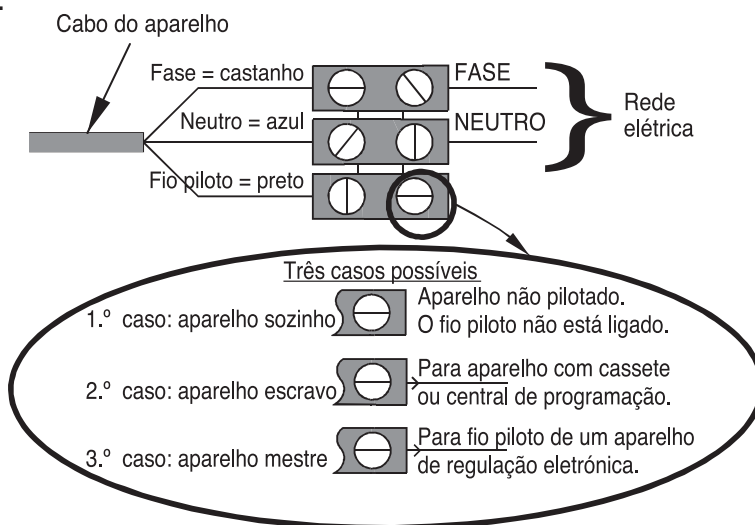

### Teste de ligação do fio piloto

Pode ligar o fio piloto se a sua casa estiver equipada com uma central de programação, um programador ou um gestor de energia. Neste caso, para verificar a transmissão correta das ordens de programação, proceda às seguintes verificações:

Ordens recebidas	Sinal a transmitir	Modo obtido
Ausência de corrente	—	CONFORTO
230 v durante 3 s	⚡	CONFORTO -1°C
230 v durante 7 s	⚡	CONFORTO -2°C
230V	⤴	ECO
-115 V negativo	⤴	ANTIGELO
+115 V positivo	⤴	PARAGEM AQUECIMENTO LIMITAÇÃO DE CARGA

## INSTALAR O AQUECEDOR SOBRE O SUPORTE DE PAREDE

- Coloque o aparelho sobre o suporte S de acordo com o esquema.
- Aproxime o aparelho do suporte e levante-o (flechas 1 e 2).
- Introduzir as patilhas do suporte nos orifícios do aparelho, abaixar (flecha 3).
- Bloquear, dando meia volta aos dois bloqueadores V; o seu aparelho está fixado.

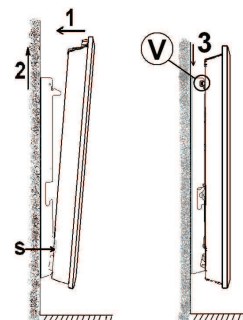

## Funcionamento

### A caixa de comando

Para mais conforto e economia, o seu aparelho está equipado com uma caixa de comando com ecrã digital. Ela permite regular todas as funções do aquecedor.

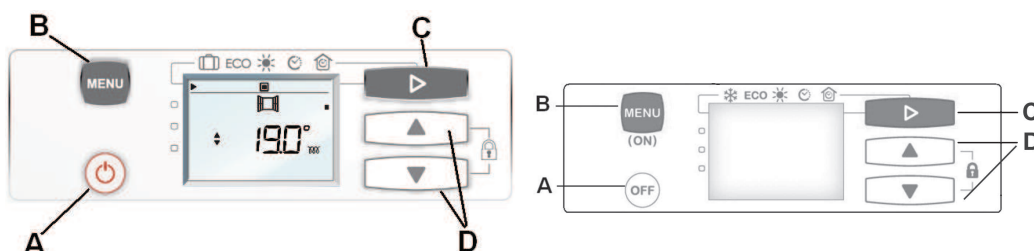

- A Colocação em funcionamento / modo de espera
- B Programação / Ajustes
- C Seleção dos modos de aquecimento
- D Botões de regulação



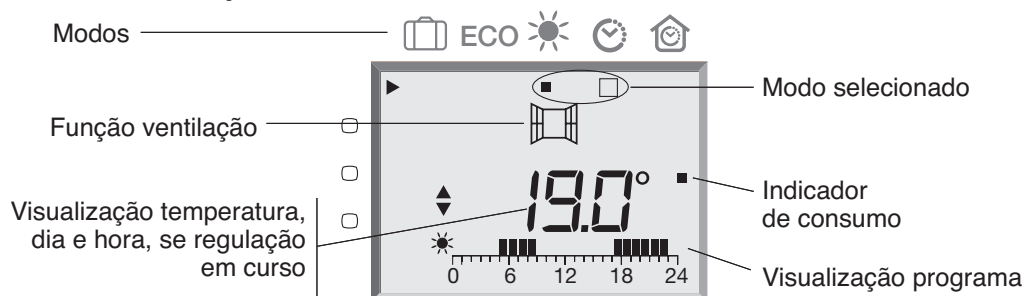

- A Desligamento do aquecimento
- B Colocação em funcionamento/Configurações da programação interna
- C Seleção dos modos
- D Botões de regulação

### As diferentes indicações no ecrã





Depois de 2 minutos de inatividade, o ecrã volta à visualização em curso.

## OS DIFERENTES MODOS DE AQUECIMENTO



Pictograma	Designação	Quando utilizar este modo?
	Conforto	Está em casa.
<b>ECO</b>	Eco	Está ausente entre 2 a 48 horas, ou está a dormir.
	Antigelo	Fica ausente por mais de 48 horas ou é Verão. A temperatura Antigelo é fixada a aproximadamente a 7°C, e não pode ser alterada.
	Programação interna	Pretende que o seu aquecedor siga as ordens de uma programação. Pode escolher um dos cinco programas propostos pressionando duas vezes o botão MENU (B). Consulte a página 11 para explicações mais detalhadas.
	Programação centralizada	Esses modos de aquecimento são acessíveis unicamente em caso de presença de um sistema de programação centralizada (pelo fio piloto) na sua instalação.

## Primeira utilização

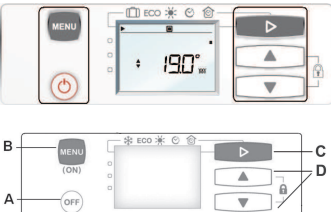

### COLOCAR O APARELHO EM FUNCIONAMENTO

<p>Para colocar o aparelho em funcionamento, oprima o botão Colocação em funcionamento (A).</p>	 	 <p>O aparelho mostra a temperatura de conforto. Aquando da primeira colocação em funcionamento, o aparelho está regulado em modo Conforto, a 19°C.</p>
---	---	---











### Ativar o ecrã

<p>Se o ecrã não está iluminado, prima qualquer botão para reativar a iluminação do ecrã.</p>		 <p>Pode agora premir o botão correspondente à regulação que pretende realizar.</p>
---	---	---

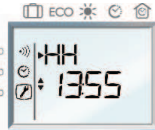
## COLOCAR O APARELHO EM MODO DE ESPERA

<p>Para colocar o aparelho em modo de espera, mantenha oprimido o botão de Colocação em modo de espera (A).</p>		 <p>O ecrã apaga-se.</p>
---	---	---

## AJUSTAR A HORA E O DIA



<p>Para aceder ao ajuste do dia e da hora, oprima várias vezes o botão Menu (B) até à seleção da chave </p>		 <p>As letras aparecem no ecrã: pode começar o ajuste da hora.</p>
<p>Para alterar a hora, pressione ▲ ou ▼ (D), as horas piscam. Pressione novamente ▲ ou ▼ (D) para mudar a hora.</p>		 <p>Depois de 5 segundos de inatividade, a hora é validada automaticamente e os minutos começam a piscar.</p>
<p>Depois do ajuste das horas, pode aceder ao ajuste dos minutos, oprimindo ▲ ou ▼ (D)</p>		 <p>Depois de 5 segundos de inatividade, os minutos são validados automaticamente.</p>
<p>Depois do ajuste das horas/minutos, pode aceder ao ajuste do dia, oprimindo ► (C).</p>		 <p>As letras aparecem no ecrã: pode começar o ajuste do dia.</p>
<p>Para alterar o dia, pressione ▲ ou ▼ (D), o dia pisca. Pressione novamente ▲ ou ▼ (D) para mudar o dia.</p>		 <p>Depois de 5 segundos de inatividade, o dia é validado automaticamente.</p>

## Utilização dos modos

### AQUECER O AMBIENTE: UTILIZAÇÃO DO MODO CONFORTO



Este modo permite-lhe obter a temperatura ambiente pretendida na divisão. As luzes do indicador de consumo permitem otimizar os ajustes (ver página 62).

#### Como ativar esse modo?

<p>Para ativar o modo Conforto, pressione várias vezes ► (C) até que o cursor se posicione no modo Conforto ☀</p>		 <p>Por omissão, a temperatura de Conforto é de 19°C.</p>
---	---	--

A temperatura recomendada do modo Conforto é de 19°C.  
O modo Conforto vai de 12,5°C a 28°C.

#### Como alterar a temperatura pretendida?

<p>Para alterar a temperatura visualizada, pressione ▲ ou ▼ (D), a temperatura pisca. Pressione novamente ▲ ou ▼ (D) para mudar a temperatura.</p>		 <p>O indicador de aquecimento ☀ aparece no ecrã se a temperatura ambiente for inferior à indicada no ecrã. Depois de 5 segundos de inatividade, a temperatura é validada.</p>
--	---	---



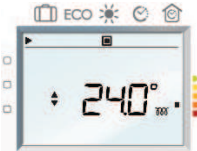

São necessárias 6 horas, no mínimo, para que a temperatura se estabilize na divisão.







<p>Se a temperatura da divisão não lhe convém, pressione ▲ ou ▼ (D), a temperatura pisca. Pressione novamente ▲ ou ▼ (D) para ajustar a temperatura.</p>		 <p>Quando mais elevada for a temperatura indicada no ecrã, mais o indicador de consumo deslocar-se-á para baixo (indicador laranja e vermelho).</p>
--	---	---

### AUSENTAR-SE DURANTE ALGUMAS HORAS: UTILIZAÇÃO DO MODO ECO

É recomendável utilizar este modo para períodos de ausência entre 2 a 48 horas, ou durante a noite, nomeadamente nos quartos de dormir.

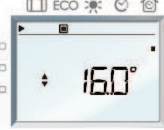
A temperatura ECO máxima é de 19°C ou 0,5°C inferior à temperatura de Conforto.

<p>Para ativar o modo ECO, pressione várias vezes ► (C) até que o cursor se posicione no modo ECO.</p>		 <p>Por omissão, a temperatura do modo ECO é de 15,5°C.</p>
--	---	---

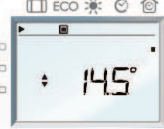
	Visualização Conforto	Visualização Eco
<p>Passagem do modo Conforto ao modo ECO: temperatura -3,5°C mais baixa relativamente à temperatura de Conforto.</p>		
<p>O pictograma -3,5°C não aparece no ecrã: a diferença com a temperatura ajustada do modo Conforto é diferente de -3,5°C.</p>		
<p>Se diminuir a temperatura de Conforto abaixo da temperatura Eco, a temperatura Eco diminuirá automaticamente -0,5°C relativamente à temperatura de Conforto.</p>		
<p>Se aumentar a temperatura de Conforto, a temperatura Eco não mudará.</p>		



## Como alterar a temperatura pretendida?

Se quiser, pode alterar a temperatura visualizada premindo ▲ ou ▼ (D), a temperatura pisca. Pressione novamente ▲ ou ▼ (D) para mudar a temperatura.



Depois de 5 segundos de inatividade, a temperatura ECO é validada automaticamente.

## AUSENTAR-SE POR MAIS DE 48 HORAS: UTILIZAÇÃO DO MODO ANTIGELO

Para ativar o modo Antigelado , pressione várias vezes ► (C) até que o cursor se posicione no modo Antigelado .



A temperatura Antigelado  é pré-ajustada a aproximadamente 7°C (±3°C) e não pode ser alterada.

## PROGRAMAR O SEU PERÍODO DE AQUECIMENTO UTILIZAÇÃO DO MODO DE PROGRAMAÇÃO INTERNA

Antes de ajustar a programação, é preciso acertar a hora do aquecedor ou assegurar-se de que a data e a hora estão corretas.

### Descrição

Pode programar os seus períodos de temperatura de Conforto  e ECO utilizando um dos cinco programas preestabelecidos.

Cinco programas são preestabelecidos: P1, P2, P3, P4 e P5 e não alteráveis.

	0h	1h	2h	3h	4h	5h	6h	7h	8h	9h	10h	11h	12h	13h	14h	15h	16h	17h	18h	19h	20h	21h	22h	23h	
P1																									
P2																									
P3																									
P4																									
P5																									

**P1** é indicado para uma presença constante, por exemplo, no fim de semana (modo Eco de 0 h às 10 h, modo Conforto das 10 h a 0 h).

**P2** é indicado se está ausente durante o dia (modo Eco de 0 h às 6 h e das 9 h às 17 h, modo Conforto das 6 h às 9 h e das 17 h às 23 h).



**P3** é indicado se está ausente durante o dia, mas volta ao meio-dia (modo Eco das 23 h às 5 h, das 9 h às 12 h e das 14 h às 17 h, modo Conforto das 5 h às 9 h, das 12 h às 14 h e das 17 h às 23 h).

**P4** Conforto permanente.



**P5** Eco permanente.

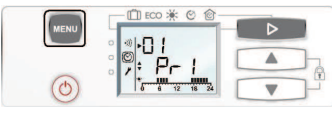



### Como atribuir um programa diário?

<p>Para aceder ao programa diário, pressione <b>MENU</b> até ao pictograma </p>		 <p>Para a segunda-feira (01), o programa por omissão é P1.</p>
--	---	--

### Manter o programa seleccionado?

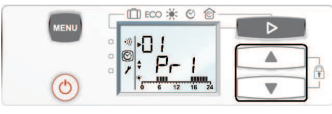

<p>Se quiser manter o programa P1 na segunda-feira: pressione <b>▶</b> (C) para passar ao dia seguinte.</p>		 <p>02 (terça-feira) aparece no ecrã com o programa P1 por omissão.</p>
---	---	--

<p>Se quiser alterar o programa da segunda-feira: pressione <b>▲</b> ou <b>▼</b> (D) para passar ao programa seguinte. Seleccione o programa pretendido.</p>		 <p>01 (segunda-feira) aparece no ecrã com o programa escolhido. O programa pisca e depois de 5 segundos de inatividade, o programa escolhido é validado automaticamente.</p>
--	---	--

### Atribuir um programa diário a todos os dias da semana.

Deve proceder da mesma maneira para todos os dias da semana, até ao domingo, mantendo ou alterando o programa seleccionado.

### Como ativar a programação interna?

<p>Para ativar a Programação interna, pressione <b>▶</b> (C) e seleccione .</p>		 <p>O pictograma da programação interna e a função em curso, conforme o programa escolhido, aparecem no ecrã.</p>
--	---	--



## PROGRAMAR O SEU PERÍODO DE AQUECIMENTO: UTILIZAÇÃO DO MODO DE PROGRAMAÇÃO CENTRALIZADA

Antes de ajustar a programação, é preciso acertar a hora do aquecedor ou assegurar-se de que a data e a hora estão corretas.

 corresponde à utilização de um programador centralizado.



**Nota :** Em caso de ausência de ordem ao fio piloto, o aquecedor funciona em modo Conforto. O tempo de passagem do modo Conforto para o modo Eco é de cerca de 12 segundos. As ordens Antigelo e Limitação de carga são prioritárias relativamente aos modos Eco e Conforto.

### Como ativar a programação centralizada?



<p>Para ativar a Programação centralizada, pressione várias vezes ► (C) até que o cursor se posicione no modo Programação centralizada .</p>		 <p>O pictograma da programação centralizada e a função em curso aparecem no ecrã.</p>
---	---	---

## Utilizar as funções de economia de energia:

### FUNÇÃO DE DETEÇÃO AUTOMÁTICA DE VENTILAÇÃO

Para utilizar esta função, é recomendável ajustar o seu aquecedor para os modos ,  ou .

Esta função é complementar à programação.

A função de deteção automática de ventilação  deteta a abertura e o fecho das janelas da divisão. O aparelho passa automaticamente ao modo Antigelo  (7°C) quando deteta uma janela aberta e volta a subir à temperatura instruída quando deteta o fecho da mesma.

A utilização da função de deteção automática de ventilação  não é recomendável em corredores e divisões situadas perto de uma porta de entrada que se abra para o exterior ou para uma garagem.



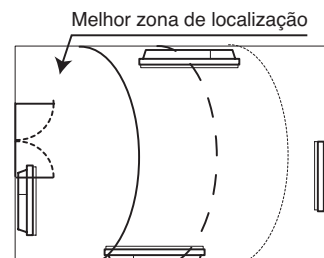

O seu aquecedor reage a aberturas e fechos de janelas consoante diversas variáveis, nomeadamente:

- a temperatura pretendida na divisão;
- a temperatura exterior;
- a configuração da sua instalação (localização do aquecedor relativamente à janela).

Ao detetar a abertura e o fecho da janela, a função Ventilação permite adotar naturalmente um gesto ecocidadão: não aquecer a habitação inutilmente ao ventilá-la, proporcionando mais conforto e economia.

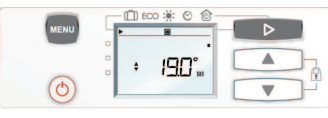

## Como ativar ou desativar essa função?

<p>Para aceder à função de deteção automática de ventilação, pressione uma vez .</p>		
<p>Para ativar a função, seleccionar «ON» com ▲ ou ▼ (D).</p>		<p>O pictograma da deteção automática de ventilação aparece.</p>
<p>Para desativar a função, seleccionar «OFF» com ▲ ou ▼ (D).</p>		<p>O modo em curso aparece e a janela desaparece.</p>
<p>Para sair do modo de regulação, pressione várias vezes .</p>		

A temperatura de funcionamento é de 7°C durante todo o período de ventilação da sua divisão. Ao fechar a janela, o aquecedor retoma o funcionamento inicial.

**A duração máxima de ventilação prevista é de 2 horas. Depois de 2 horas, o aquecedor retoma o aquecimento de qualquer forma.**

**Nota :** Se a função não satisfaz a sua necessidade, pode interromper o aquecimento manualmente durante a ventilação do ambiente (oprimir o botão de Colocação em modo de espera (A) ☺).

## FUNÇÃO INDICADOR DE CONSUMO

O consumo de um aquecedor elétrico depende, entre outros, da temperatura pedida. A temperatura recomendada pelos poderes públicos é de 19°C em modo Conforto (15,5°C em modo Eco).

A função «indicador de consumo» permite que se oriente relativamente à temperatura recomendada.

Assim, em função da temperatura pedida:

- Se a marca preta do ecrã está diante do segundo pictograma laranja ou do vermelho, uma atitude mais ecológica seria baixar significativamente a temperatura pedida.
- Se a marca preta do ecrã está diante do primeiro pictograma laranja, uma atitude mais ecológica seria baixar ligeiramente a temperatura pedida.
- Se a marca preta está diante do pictograma verde, está na temperatura recomendada e já adotou uma atitude ecológica.



## BLOQUEAR OS COMANDOS

A fim de evitar qualquer manipulação intempestiva de crianças da caixa de comando, aconselhamos bloqueá-la.

### Como bloquear os comandos?

Para bloquear os comandos, mantenha pressionado ▲ ou ▼ (D) simultaneamente durante alguns segundos.



Um cadeado aparece no ecrã: não pode mais alterar os ajustes.

### Como desbloquear os comandos?

Para desbloquear os comandos, mantenha pressionados ▲ ou ▼ (D) simultaneamente durante alguns segundos.



O cadeado desaparece do ecrã: os ajustes podem ser alterados.

## Modo instalador

### TEMPERATURA MÁXIMA: T° MAX

O seu aparelho oferece a possibilidade de estabelecer uma temperatura máxima que não pode ser ultrapassada em modo Conforto: O intervalo é compreendido entre 19°C a 28°C.

Mantenha pressionados simultaneamente durante alguns segundos os botões MENU e ▲, t° MAX 28°C aparece.



Ajuste a temperatura máxima pretendida pressionando ▲ ou ▼. Depois de 5 segundos de inatividade, a temperatura é validada automaticamente.

Para desativar esta função, prima simultaneamente durante alguns segundos os botões MENU e ▲.



O ecrã volta ao modo em curso.



### CALIBRAR A TEMPERATURA

Depois de várias horas de aquecimento, é possível, em função da sua instalação, que observe uma temperatura diferente da indicada no seu aquecedor. Nesse caso, pode calibrar o aquecedor para ajustar a temperatura. O valor de calibração está compreendido entre -2°C a +2°C.

Mantenha pressionados simultaneamente durante alguns segundos os botões MENU e ▲, e depois, pressione uma vez ► (C), t° OFFSET aparece.



















Defina a diferença de temperatura pressionando ▲ ou ▼. Depois de 5 segundos de inatividade, a temperatura é validada automaticamente.

<p>Para sair desta função, pressione simultaneamente durante alguns segundos  e .</p>		<p>O ecrã volta ao modo em curso.</p>
---	---	---------------------------------------

## BLOQUEAR AS CONFIGURAÇÕES

É possível bloquear as configurações do seu radiador e desse modo, tornar inacessível os menus e as alterações dos modos de funcionamento. A colocação em funcionamento/modo de espera, a configuração da temperatura de referência, o bloqueio dos comandos e das configurações avançadas permanecem acessíveis.













<p>Para bloquear a configuração, mantenha pressionados simultaneamente, por alguns segundos  e . Pressione  até que «br não» seja exibido.</p>		<p>Pressione  ou  para selecionar SIM. Espere 5 segundos. Para sair desta função, pressione simultaneamente, por alguns segundos  e . As configurações são bloqueadas (a temperatura do modo em uso poderá ser modificada).</p>
<p>Para desativar esta função, pressione e mantenha pressionado simultaneamente por alguns segundos  e . Pressione  até que «br sim» seja exibido.</p>		<p>Pressione  ou  para selecionar NÃO. Espere 5 segundos. Para sair desta função, pressione simultaneamente, por alguns segundos  e . As configurações são bloqueadas (a temperatura do modo em uso poderá ser modificada).</p>

## REGISTRAR UM CÓDIGO DE ACESSO

Você pode criar um código pessoal para acessar as configurações avançadas para controlar o acesso às funções de: «Salvar uma temperatura máxima», «Ajustar a temperatura», «Bloquear as configurações».

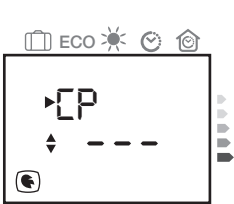











<p>Para salvar um código de acesso, pressione e mantenha pressionado simultaneamente por alguns segundos  e . Pressione  até que «CP não» seja exibido.</p>		<p>Pressione  ou  para inserir a sua código. Quando sua código for inserida, espere 5 segundos. Para sair desta função, pressione simultaneamente por alguns segundos  et . O acesso às configurações avançadas está protegido por código.</p>
--	---	---

Anote aqui sua código de acesso pessoal:

<p>Para acessar as configurações avançadas, mantenha pressionado simultaneamente por alguns segundos  e .</p>		<p>Pressione  ou  para inserir a sua código. Espere 5 segundos. Será possível então o acesso às configurações avançadas.</p>
<p>Para desativar a código de acesso, volte nas configurações avançadas e pressione simultaneamente por alguns segundos  e .</p> <p>Insira sua código. Espere 5 segundos. Pressione  até que «CP» e sua código sejam exibidos.</p>		<p>Pressione  ou  até que «não» seja exibido (entre 000 e 999). Espere 5 segundos. Para sair desta função, pressione simultaneamente por alguns segundos  e .</p> <p>O acesso às configurações avançadas não estará mais protegido por código.</p>

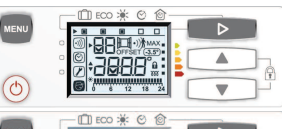
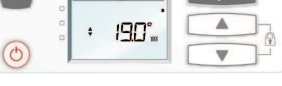
## REPOR A REGULAÇÃO BÁSICA DE FÁBRICA

O seu aparelho oferece a possibilidade de repor a regulação básica de fábrica (temperatura recomendada, programação inicial).

<p>Mantenha pressionados simultaneamente durante alguns segundos  e , e depois, pressione 3 vezes  (C). Para ativar a função, selecionar «SIM» com os botões de ajuste  ou  (D).</p>		<p>«FS» «OFF» aparece no ecrã. Pressione  ou  (D), seleccione «on». Depois de 5 segundos de inatividade, a sua escolha é validada automaticamente.</p>
<p>Todas as indicações aparecem no ecrã.</p>	 	<p>Depois de um minuto de inatividade ou ao pressionar simultaneamente durante alguns segundos  e , o aparelho coloca-se em modo Conforto  a 19°C. O modo ECO é a 15,5°C. As funções de economia de energia e as programações estão desativadas.</p>

## A LIMITAÇÃO DE CARGA

Os nossos aparelhos são compatíveis com diferentes sistemas de limitação de carga. No entanto, não deve utilizar a limitação de carga por corte de alimentação elétrica porque o sistema é incompatível com os nossos aparelhos. Ele deteriora o termóstato.

Durante os períodos de limitação de carga, o aquecedor indica «OFF». Ele volta, em seguida, ao seu modo de funcionamento inicial.

## MANUTENÇÃO

Para conservar os rendimentos do aparelho, cerca de duas vezes por ano, é necessário proceder à eliminação de poeiras das entradas e saídas de ar com um aspirador ou uma escova. A cada cinco anos, mandar revisar o interior do aparelho por um profissional. O revestimento do aparelho pode ser limpo com um pano húmido. Nunca utilizar produtos abrasivos ou solventes.

## EM CASO DE PROBLEMAS

Problemas encontrados	Verificação a realizar
O aquecedor não aquece.	<p>Verifique se o modo Conforto ☀ está ativado.</p> <p>Se está em programação, verifique se o programador está em modo CONFORTO.</p> <p>Assegure que os disjuntores da instalação estão armados ou que o limitador de carga (se houver) não cortou a alimentação do aquecedor.</p> <p>Verifique a temperatura do ar da divisão: se estiver muito elevada, o pictograma de aquecimento não se acende: o aquecedor não aquece.</p>
O aquecedor aquece todo o tempo.	Verifique se o aquecedor não está situado numa corrente de ar ou se o ajuste de temperatura não foi alterado.
O aquecedor não aquece o suficiente.	<p>Aumente a instrução de temperatura de Conforto.</p> <p>Se a regulação estiver no máximo, faça as seguintes verificações:</p> <ul style="list-style-type: none"> <li>- Verifique se existe um outro modo de aquecimento na divisão.</li> <li>- Assegure que o seu aquecedor aquece apenas a divisão (porta fechada).</li> <li>- Mandar verificar a tensão de alimentação do aparelho.</li> <li>- Verifique se a potência do seu aquecedor está adaptada ao tamanho da divisão (recomendamos em média 100 W/m<sup>2</sup> para uma altura de teto de 2,50 m).</li> </ul>
O pictograma de aquecimento ☀ fica a piscar.	A sonda está desligada ou não está a funcionar. Contacte o seu instalador.
Vestígios de sujidades aparecem na parede à volta do aquecedor.	As sujidades estão ligadas à má qualidade do ar ambiente. Neste caso, é recomendável verificar a boa ventilação do local (ventilação, entrada de ar, etc.) e a limpeza do ar, e evitar fumar no interior. Essas sujidades não justificam a substituição sob garantia do aparelho.
O pictograma de aquecimento ☀ aparece no ecrã quando o aquecedor está em modo ECO.	Esse funcionamento é normal. O aquecedor pode aquecer de modo a manter uma temperatura Eco.
O aquecedor aquece quando a janela está aberta.	<p>Pode haver um lapso de tempo entre a abertura da janela e a paragem do aquecimento.</p> <p>Se esse lapso de tempo parece muito longo, pode interromper o aquecimento manualmente.</p>
Para os aparelhos equipados com um sistema de programação ou comandado por intermédio do fio piloto.	
O aquecedor não segue as ordens de programação externas.	Assegure-se da correta utilização da central de programação (ver manual de utilização). Verifique se o fio piloto está corretamente ligado à central. Verifique se o aparelho está em modo Programa e se o programa externo «Centralizado» está atribuído ao dia pretendido da semana.
A superfície do aquecedor está muito quente.	É normal que o aquecedor fique quente durante o funcionamento, estando a temperatura máxima de superfície limitada em conformidade com a norma NF Eletricidade Desempenho. No entanto, se julgar que o seu aquecedor está ainda demasiado quente, verifique se a potência está adaptada à área da divisão (recomendamos 100 W/m <sup>2</sup> para uma altura de teto de 2,50 m) e se o aquecedor não está localizado numa corrente de ar que perturba a sua regulação.
Existe uma diferença significativa entre a temperatura ambiente da divisão e a instrução de temperatura do aparelho.	É necessário esperar 6 horas no mínimo para que a temperatura se estabilize. É possível, em função da sua instalação, que observe uma temperatura diferente da indicada no seu aquecedor. Nesse caso, pode calibrar a temperatura. Consulte o parágrafo «Calibrar a temperatura», página 63.

