

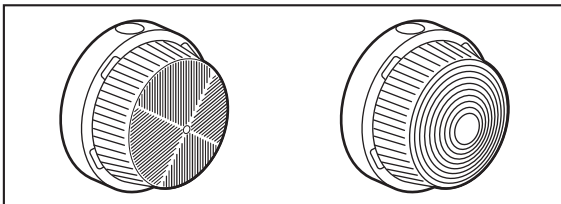





# sarlam

Hublots MAP400 / PRESTICHO



 [www.sarlam.com](http://www.sarlam.com)

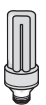

IP 44 -   
 850°/30s  
 B22 - 400 220 - IK07  
 E27 - 400 270/274 - IK07  
 E27 - 413 270/274 - IK08

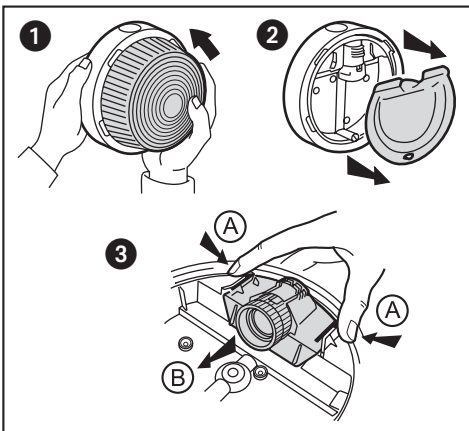
			
 max E27   B22	70 W MAP 400 53 W PRESTICHO	53 W	70 W
 max E27		23 W	



 Installation avec minuterie ou interrupteur automatique  +  Temporisation conseillée : minimum 15 minutes

